

# Aerospace TESTING

INTERNATIONAL

## Inside this issue

**// UAS AIRSPACE**  
Exclusive report on the FAA's tests to assess NASA's UAS traffic management research platform

**// FATIGUE TESTING**  
Are existing 'metal-centric' standards for fatigue testing out of date, given the growth in composites?

**// DATA ACQUISITION**  
A new, non-intrusive means of instrumenting aircraft for flight test activities

Behind the scenes at General Electric's new US\$100m combustor test cell, specially built to generate the pressures and temperatures required to test the GE9X

# Testing the world's biggest commercial jet engine

NEW

# PULSE REFLEX™ ACOUSTIC CAMERA

## SEEING IS BELIEVING



Take a snapshot or shoot a video for instant sharing

Noise spectra with clear indication of overall sound power values

Spectrogram for clear visualization of structure in the noise

You might not believe how fast the latest addition to the PULSE Reflex™ family is to set up. The acoustic camera, offering all the well-known reliability and quality of Brüel & Kjær, is an easy-to-use, portable system for visualizing sound in aircraft cabins, cockpits, or cargo bays – and it takes less than four minutes to be up and running.

Highly suitable for the aerospace industry and for both stationary and non-stationary measurements, use this versatile camera to troubleshoot problem areas, instantly sharing snapshots and analyzing recordings.

**Brüel & Kjær**   
BEYOND MEASURE

**Brüel & Kjær Sound & Vibration Measurement A/S**  
DK-2850 Nærum · Denmark  
Telephone: +45 77 41 20 00 · Fax: +45 45 80 14 05  
info@bksv.com

[www.bksv.com/acousticcamera](http://www.bksv.com/acousticcamera)





**Global briefing**

- 4 // **WORLD TEST UPDATE**  
The latest testing news from around the globe
- 6 // **NEWS: GRIPEN-E**  
Saab's next-gen fighter revealed
- 9 // **NEWS: AURORA X-PLANE**  
A subscale VTOL X-Plane flies
- 11 // **NEWS: CS2 DEMO HELICOPTER**  
Airbus's super-fast green chopper
- 12 // **HEAD TO HEAD**  
Is 'there are no new accidents, only new victims' still true?



89 // **PRODUCTS AND SERVICES**  
All the latest product innovations, case studies, company news and more

104 // **AFT CABIN**  
B-29 'Doc' is about to fly again after 60 years

**Inside this issue**

- 14 // **UAS airspace trials**  
NASA and the FAA continue to test a UAS traffic management (UTM) system to pave the way for routine drone flights in US airspace
- 22 // **Finnish Air Combat Centre**  
Meet the test and evaluation unit dedicated to testing and extending the operational life of Finland's fleet of F/A-18 Hornets
- 30 // **Engine testing**  
GE Aviation's brand-new US\$100m facility in Evendale, Ohio, built to test the world's largest commercial jet engine; and the latest sand ingestion testing for the GP7200
- 38 // **AWC Nifti**  
Australia's Air Warfare Centre has developed a non-intrusive flight test instrumentation solution in a bid to help reduce flight testing time and cost
- 48 // **Testing talk: Paul Thill**  
Meet the man responsible for securing all data acquired from flight test programs for Bombardier's new C-series aircraft family
- 58 // **Searchmaster**  
Testing the Searchmaster, a new airborne surveillance radar, is key to extending the operations of maritime patrol aircraft
- 62 // **Fatigue testing**  
Regulators' 'metal-centric' standards for fatigue testing may need to change for composites and hybrid structures
- 70 // **CH-53K flight trials**  
Active-duty US Marine Corps pilots are being put into the CH-53K early in testing to improve test program efficiencies
- 80 // **Fokker 100**  
The French military is cooperatively developing a Fokker 100 into a test aircraft - dubbed 'Pinocchio' for its fighter jet nose

## // The glue that holds us together

With a fan diameter of 132in, just short of the length of a compact car, the new GE9X jet engine destined for the Boeing 777x (and pictured on our cover) is quite simply a beast of a powerplant. However, it wasn't the scale of the engine itself that got our writer, Paul Eden, excited when researching the latest engine testing developments (see page 30), but rather the scope of the tests themselves.

"What really impressed me were the extreme test conditions, especially temperatures and pressures," says Eden, who in the same article also examines the latest sand ingestion trials that the Engine Alliance (EA) is carrying out with its GP7200 unit, in service with a number of Middle East carriers. "I was also struck by the severity of the ingestion testing and the lengths to which EA went to ensure the muck they were throwing down the engine was fully representative of that encountered operationally."

GE Aviation has spent well over a US\$100m on its new combustor test cell, initially for the GE9X, but with a view to supporting future projects by building on its technology. Continued, projected growth in the commercial aerospace sector makes it easier to justify such expense; however, that's not to say money is no object in the aerospace testing sector. Quite the opposite applies to military programs, as governments continue to cut defense budgets in an effort to better balance the books and avoid austerity measures elsewhere more likely to incur the wrath of voters.

In fact our exclusive feature on page 38 highlights how the Australian Defence Force (ADF) has developed a non-intrusive means of instrumenting aircraft for flight test activities, motivated by a strong desire to reduce the costs associated with flight testing.

Created by the Royal Australian Air Force's newly formed Air Warfare Centre (AWC), the approach first

came to the attention of freelancer Nigel Pittaway following a presentation at the recent Air Power Development Centre Conference by test engineer Group Capt. Toby Bearman. "It described how a new AWC innovation is harnessing novel technology in the multidomain space to save flight test time for the ADF," explains Pittaway.

"For a medium-size force like the Australian Defence Force, it is becoming more difficult to dedicate an aircraft such as the Lockheed Martin Joint Strike Fighter, each of which will cost around US\$90m, purely for flight testing," notes Pittaway in the article.

The solution currently under development uses commercially available glue strips to fit data-capturing sensors to a test aircraft, and the sensors themselves use wi-fi to communicate with the data acquisition unit and to collect information. This approach may well mean no longer having to take an expensive fighter jet off-line for months or even years at a time.

An equal amount of innovation and teamwork is evident in a unique project detailed by Nunzio Caccavo, a flight test engineer at Fokker Services, on page 80. Involving partners from three countries, it provides a strong argument for greater European integration – not less (the referendum on whether the UK should stay in or leave the European Union was imminent as this issue went to press). In light of Rolls-Royce's recent warning that a British exit from the EU could delay its decision to invest in a new aero-engine testing facility at its Derby-based plant in the UK, and with many experts warning that 'Brexit' could spell a possible recession for both the UK and Europe, the need to work together and save money through investing in the right technology has never been greater.

**Anthony James, editor-in-chief**

## // Contributors



**PAUL EDEN**

Editor of the *Official Royal Air Force Annual Review* magazine and *Salute* historical journal, Paul is a dedicated aerospace writer, editor and blogger



**IAN GOOLD**

A former air-transport editor at *Flight International*, Ian began his freelance writing career in 1993, specializing in non-military aerospace and aviation



**GEORGE COUPE**

George is a journalist and editor with many years of experience writing for science, engineering and technology publications, as well as the national press



**FRANK COLUCCI**

The author of an early book on the AH-64 Apache, Frank has written in-depth about the rotorcraft industry and other aerospace and defense topics for more than 30 years



**NIGEL PITTAWAY**

Nigel is an experienced freelance journalist for aviation and defense publications worldwide. He is also a qualified aircraft maintenance engineer

## // The team

**EDITOR-IN-CHIEF** Anthony James  
(anthony.james@ukipme.com)

**EDITOR** Michael Jones  
(michael.jones@ukipme.com)

**PRODUCTION EDITOR** Alex Bradley  
**CHIEF SUB EDITOR** Andrew Pickering  
**DEPUTY PRODUCTION EDITOR** Nick Shepherd  
**SENIOR SUB EDITOR** Christine Velarde  
**SUB EDITOR** Alasdair Morton

**ART DIRECTOR** James Sutcliffe  
**ART EDITOR** Louise Adams

**DESIGN CONTRIBUTORS** Andy Bass, Anna Davie, Craig Marshall, Nicola Turner, Julie Welby, Ben White

**HEAD OF PRODUCTION AND LOGISTICS**  
Ian Donovan

**DEPUTY PRODUCTION MANAGER** Lewis Hopkins  
**PRODUCTION TEAM** Carole Doran, Bethany Gill, Cassie Inns, Frank Millard

**PUBLICATION DIRECTOR**  
Tom Eames (tom.eames@ukipme.com)  
**PUBLICATION MANAGER**  
Jag Kambo (jag.kambo@ukipme.com)

**CEO** Tony Robinson  
**MANAGING DIRECTOR** Graham Johnson  
**EDITORIAL DIRECTOR** Anthony James



Average net circulation per issue for the period January 1 to December 31, 2015 was 9,686

The views expressed in the articles and technical papers are those of the authors and are not endorsed by the publishers. While every care has been taken during production, the publisher does not accept any liability for errors that may have occurred. *Aerospace Testing International* USPS 020-657 is published quarterly, in March, June, September, and December by UKIP Media & Events Ltd, Abinger House, Church Street, Dorking, Surrey, RH4 1DF, UK; tel: +44 1306 743744; fax: +44 1306 742525; editorial fax: +44 1306 887546. Annual subscription price is £70/US\$108. Airfreight and mailing in the USA by agent named Air Business Ltd, c/o Worldnet Shipping USA Inc, 155-11 146<sup>th</sup> Street, Jamaica, New York 11434. Periodicals postage paid at Jamaica, New York 11431. US Postmaster: send address changes to *Aerospace Testing International* c/o Air Business Ltd, c/o Worldnet Shipping USA Inc, 155-11 146<sup>th</sup> Street, Jamaica, New York 11434. Subscription records are maintained at UKIP Media & Events Ltd, Abinger House, Church Street, Dorking, Surrey, RH4 1DF, UK. Air Business is acting as our mailing agent.

Printed by William Gibbons & Sons Ltd, 26 Planetary Road, Willenhall, West Midlands, WV13 3XT, UK. This publication is protected by copyright ©2016. Print publication: ISSN 1478-2774 Online publication: ISSN 2397-6411

**COVER IMAGE:** GE9X engine on the test stand at General Electric's facility in Peebles, Ohio



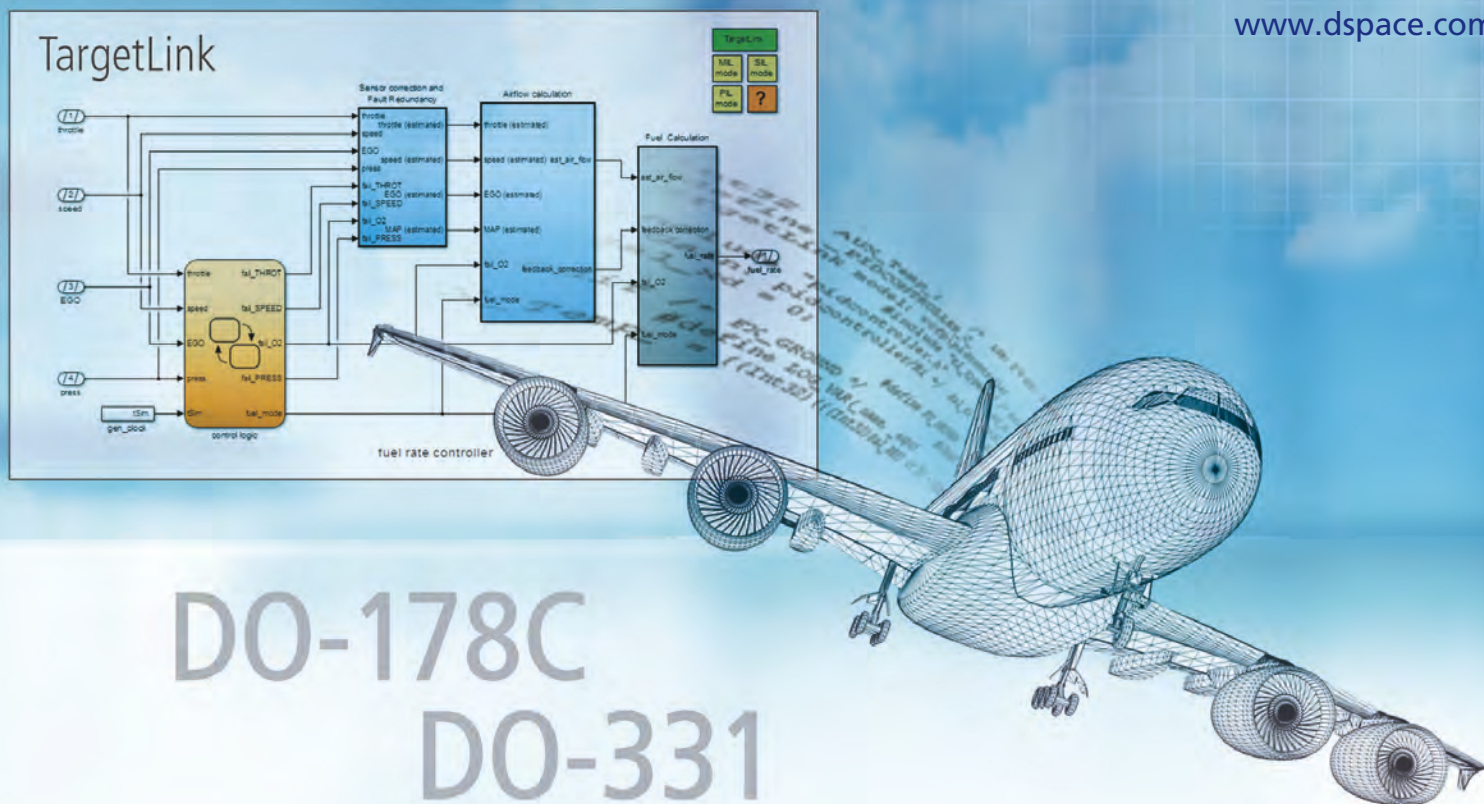

DO-178C  
DO-331

## Efficiency and High Quality – TargetLink® for Airborne Software

dSPACE TargetLink greatly facilitates software development for safety-critical avionic applications up to software level A:

- High-quality C code generation directly from Simulink®/Stateflow® models
- Powerful software design and verification features
- Wide collection of tools, the TargetLink Ecosystem, for DO-178C/DO-331, including test case generation and model checking

TargetLink C code has collected millions of miles in aviation, from business jets to wide-body aircraft.

dSPACE TargetLink – Your direct flight from model to certified code!

# WORLD test update

## // BOEING 737 MAX COMPLETES HIGH-ALTITUDE FLIGHT TESTING

The Boeing 737 MAX 8 has passed a key milestone after completing high-altitude flight testing in La Paz, Bolivia, in the first international flight for the 737 MAX flight test fleet.

El Alto International Airport's 13,300ft (4,050m) altitude tested the MAX's capability to take off and land at high altitudes, as this can affect overall aircraft flight performance.

Flight testing for the 737 MAX is on schedule. Three test airplanes have completed more than 100 flights combined. The fourth and final test airplane will make its first flight in a few weeks. First delivery is scheduled for the third quarter of 2017.

*La Paz, Bolivia*



READ MORE ON OUR WEBSITE!

## // CH-53K STARTS EXTERNAL LOADS TESTING

The new Sikorsky CH-53K heavy-lift transport helicopter conducted its first external lift of a 12,000 lb payload in April and more recently has increased its testing with a 20,000 lb lift.

Mike Torok, Sikorsky's vice president of CH-53K programs said in April, "Our flight envelope expansion efforts remain on track and we continue to make good progress toward our initial operational test assessment later this year, and ultimately full aircraft system qualification."

Since then, reports suggest the test program is progressing ahead of schedule.

Under Sikorsky's lift extension project for the King Stallion, both test aircraft will demonstrate lifting greater external loads – from an initial payload of 12,000 lb hovering, up to 27,000 lb at speeds of 120kts.

The CH-53K King Stallion is equipped with single, dual and triple external cargo hook capability. The center hook has a 36,000 lb capability and the dual-point hooks are each capable of carrying up to 25,200 lb.

*West Palm Beach, Florida*



MORE ON THE CH-53K ON PAGE 70



## // GROUND TESTING BEGINS ON GE9X

Ground testing is underway on the first full development GE9X engine at GE Aviation's Peebles Testing Operation in Ohio. The GE9X engine will power Boeing's new 777X aircraft and is the world's largest commercial aircraft engine.

Ground testing will generate data on the full engine system and aerodynamic performance, mechanical verification and aero thermal system validation.

Maturation testing of the GE9X engine began approximately five years ago and has progressed from component level all the way to the first full engine to test (FETT). FETT brings all the GE9X technologies together to demonstrate their operability as a complete propulsion system.

Engine certification is anticipated in 2018.

*Peebles, Ohio*

READ MORE ON THE GE9X ON PAGE 30

## // THIRD AW609 PROTOTYPE BEGINS GROUND RUN TESTING

Leonardo-Finmeccanica announced on May 4 that the third prototype (A/C3) of the AgustaWestland AW609 TiltRotor has completed its first ground run at the company's facilities in Cascina Costa, Italy, marking a critical milestone as the program advances toward a resumption of flight testing activities.

Aircraft AW609 A/C3 began restrained ground run testing with all engines and systems operating. These tests prepare the prototype for FAA certification flight testing this summer at the company's Philadelphia, Pennsylvania, facility, where it will demonstrate that its capabilities satisfy a stringent set of airworthiness standards for the world's first commercial powered lift aircraft.

Testing plans for the A/C3 also include icing trials in the winter of 2016 to demonstrate its capabilities in icing conditions.

The ground run of the third prototype followed restarting of test activities for the first prototype (A/C1) on April 15, 2016.

*Cascina Costa, Italy*





**// UAS AIRSPACE INTEGRATION FLIGHT TESTS**

A fourth flight test program, consisting of a series of demonstrations, began at the end of April and continues through June to help NASA and FAA engineers advance technologies to integrate unmanned aircraft systems (UAS) into the US National Airspace System (NAS).

The series of flight tests will assist FAA officials in developing regulations for integration.

Conducted from NASA's Armstrong Flight Research Center in California, the Flight Test Series 4 (FT4) objective will see 15 flights and more than 270 encounters with other aircraft. Piloted aircraft will fly into different positions near or around NASA's Predator B remotely piloted aircraft, called the Ikhana.

The goal of these encounters is to test functioning of the UAS as high-speed and low-speed aircraft approach, to verify the minimum standards needed. *Edwards, California*

**SEE MORE UAS TESTING ON PAGE 14**

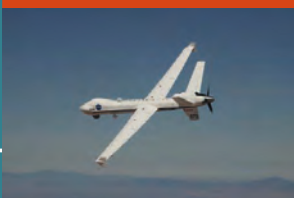

**// EMBRAER E190-E2 TAKES EARLY FIRST FLIGHT**

The Embraer E190-E2 completed its first flight on May 23, an event originally scheduled for the second half of this year. The aircraft took off from Embraer's facility in São José dos Campos, Brazil, and flew for three hours.

The flight occurred just three months after the E190-E2 made its public debut at a rollout ceremony at the factory in late February. The inaugural flight marks the beginning of the certification campaign for the aircraft, the first of three new second-generation E-Jet models. The E190-E2 is scheduled to enter service in 2018.

The first flight evaluated aircraft handling and performance characteristics, with the crew analyzing a large number of flight parameters, including speed, altitude and landing gear retraction. *São José dos Campos, Brazil*

**// JAPAN'S STEALTH JET TAKES FIRST FLIGHT**

Japan became the fourth country to test fly its own stealth jet when it carried out a test flight of the X2 demonstrator on April 22. It is hoped that the aircraft will be a boost for the domestic aerospace industry.

Japan's Ministry of Defense said the X2 took off from Nagoya Airport in Aichi Prefecture and flew approximately 15km before it touched down at Japan Air Self-Defense Force's Gifu Air Field. The X2 will be used as a platform for testing stealth and other technologies.

The prototype will undergo a further two years of testing before a decision is made on whether to develop a home-grown stealth fighter jet. Japan started the ¥39bn (US\$333m) demonstrator project in 2009 to preserve its declining aerospace industry, aiming to keep up with the latest defense capabilities and, ultimately, sell Japanese arms overseas.

*Nagoya Airport, Japan*



**For regular news updates:  
AEROSPACETESTINGINTERNATIONAL.COM**

# Gripen-E takes center stage

Saab unveiled its next generation fighter, the Gripen E, during a ceremony held in May at its Linköping site in Sweden. The aircraft presented at the roll-out is the first of the three test aircraft that will support the program.

The next-generation fighter features a completely overhauled avionics system with a sophisticated sensor suite that includes an active electronically scanned array (AESA) radar, infrared search and track (IRST), electronic warfare (EW) suite and the latest datalink technology. Saab says the aircraft will also be able to carry more weapons and deliver improved range performance as a result of a more powerful engine and the ability to carry more fuel.

The Swedish defence and security company started construction of the first test aircraft, designated '39-8', in July 2013. It will soon be followed by two more test aircraft - '39-9', which will be used for development and verification of the tactical systems, and then '39-10' for final verification of the airframe and systems. Testing is taking place at Saab in Linköping, Sweden. Initial delivery of the first fighters to Sweden and Brazil is scheduled for 2019.

Five nations currently operate the Gripen: Sweden, South Africa, the Czech Republic, Hungary and Thailand. Brazil has ordered the aircraft and it has also been down-selected in Slovakia. The Empire Test Pilots' School (ETPS) in the UK uses the Gripen as platform for test pilot training. \





# GRIPEN-E



*For regular news updates:*  
[AEROSPACETESTINGINTERNATIONAL.COM](http://AEROSPACETESTINGINTERNATIONAL.COM)

# DISCOVER SCALABLE DYNAMIC DATA ACQUISITION & ANALYSIS

- High-speed multi-channel data acquisition
- Sampling rates up to 819.2 kSa/s
- Continuous live data streaming
- Easy system setup
- Quick channel overview for 1000+ channels
- Multiple recording instances in parallel
- Flexible online graphics
- Powerful analysis tools
- Sustainable measurement data management
- Seamless integration into existing environments

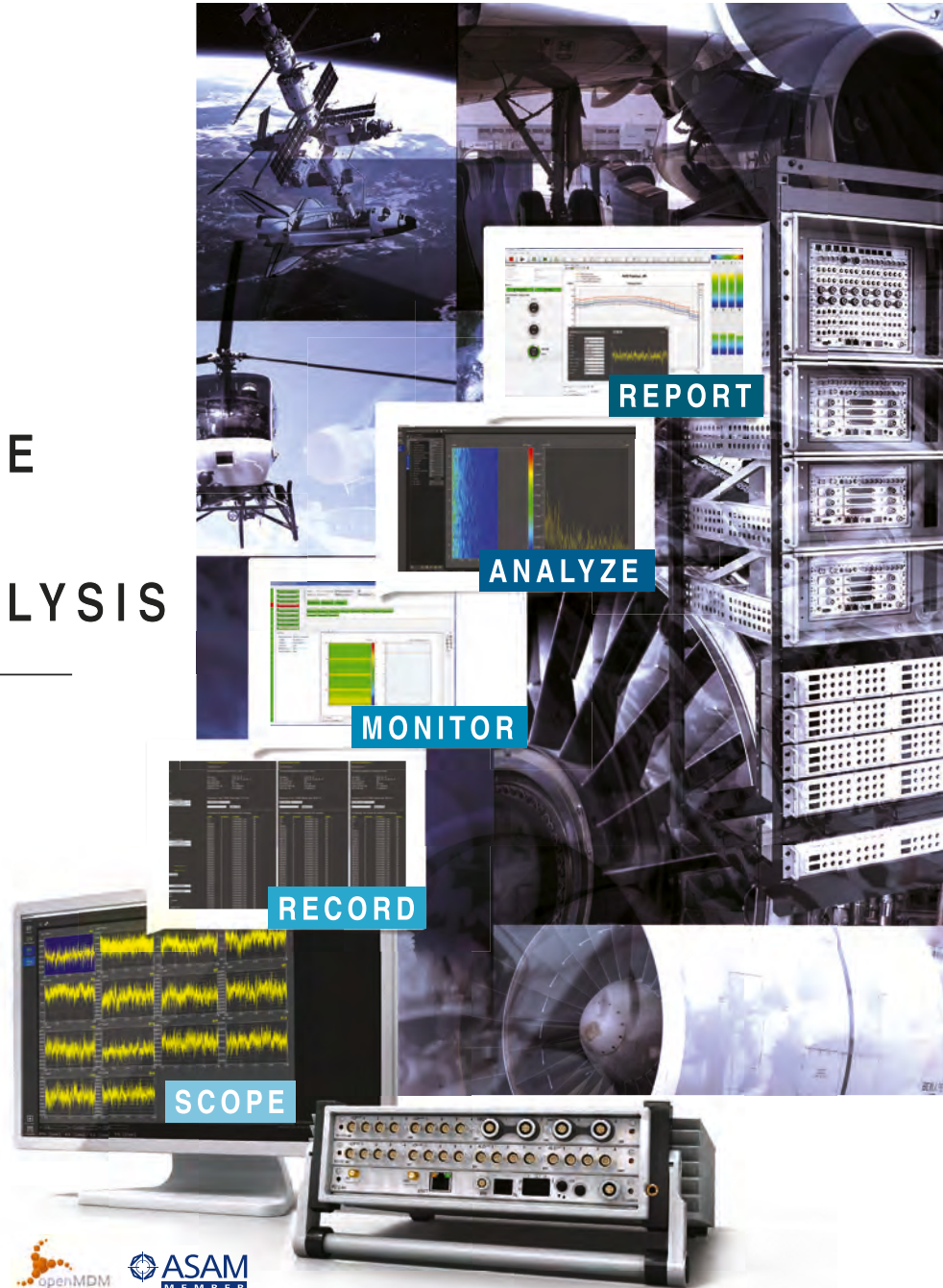

## BOOST YOUR WORKFLOW

WITH A COMPREHENSIVE APPROACH FROM TEST PREPARATION TO DATA MANAGEMENT



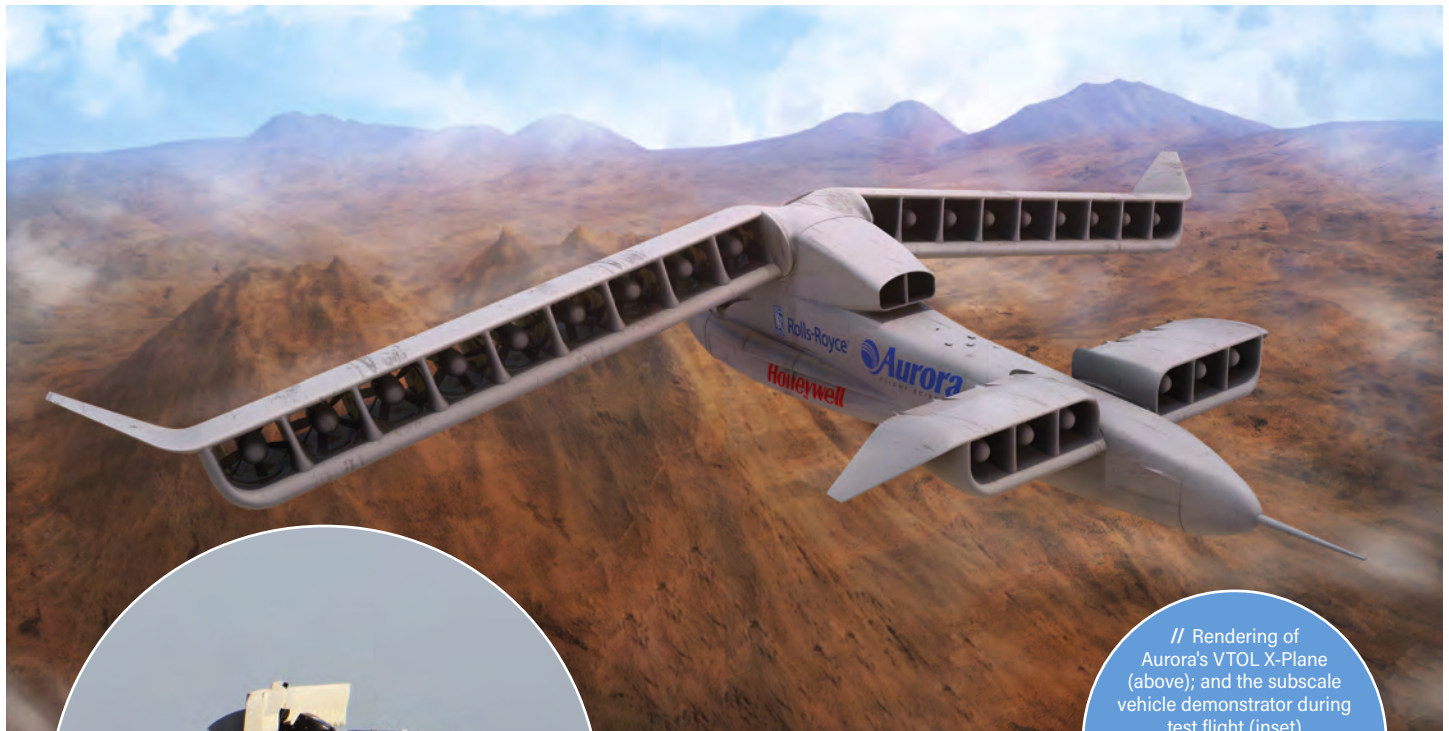

// Rendering of Aurora's VTOL X-Plane (above); and the subscale vehicle demonstrator during test flight (inset)

# Subscale VTOL X-Plane makes test flight

Aurora Flight Sciences has successfully flown a subscale vehicle demonstrator (SVD) of its LightningStrike, Vertical Take-off and Landing Experimental Plane (VTOL X-Plane) for the Defense Advanced Research Projects Agency (DARPA) at a US military facility. The flight of the subscale aircraft, which took place in April, met an important DARPA risk reduction requirement, focusing on validation of the aerodynamic design and flight control system.

"The successful subscale aircraft flight was an important and exciting step for Aurora and our customer," said Tom Clancy, Aurora's chief technology officer. "Our design's distributed electric propulsion system involves breaking new ground with a flight control system requiring a complex set of control effectors. This first flight is an important initial confirmation that the flight controls and aerodynamic design are aligning with our design predictions."

The subscale aircraft weighs 325 lb and is a 20% scale flight model of the full scale demonstrator Aurora that will build for DARPA in the next 24 months. The wing and canard of the subscale vehicle use a hybrid structure of carbon fiber and 3D-printed FDM plastics to achieve highly complex structural and aerodynamic surfaces with minimal weight. The unmanned aircraft take-off, hover and landing was controlled by Aurora personnel in a nearby ground control station with oversight and coordination by US government officials including DARPA personnel.

The VTOL X-Plane program seeks to develop a VTOL demonstrator aircraft that will achieve a top sustained flight speed of 300-400kts, with a 60-75% increase in hover efficiency over existing VTOL aircraft. Aurora's design features distributed hybrid-electric propulsion using an innovative synchronous electric-drive system. Aurora's LightningStrike team will use the next year to focus on further validation of the flight control system and configuration of the full-scale VTOL X-Plane demonstrator. \

For regular news updates:

[AEROSPACETESTINGINTERNATIONAL.COM](http://AEROSPACETESTINGINTERNATIONAL.COM)

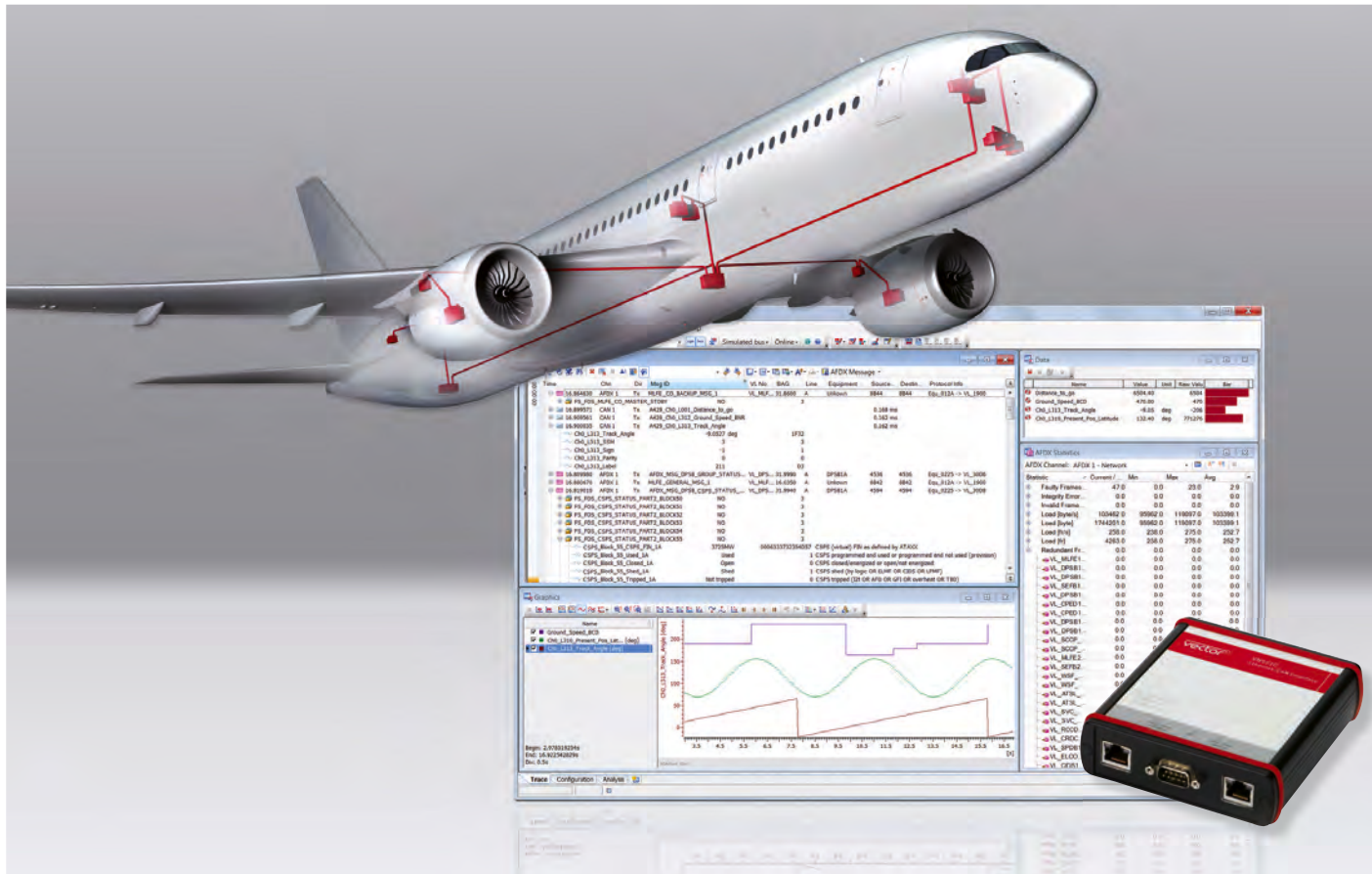

## Test your avionics network efficiently and reliably

### Mastering complexity

Benefit from the high-performance functions of the CANoe and CANalyzer tools in your avionic network development work and testing:

- > Reliably test data communication – from simple interactive testing to systematic automated tests
- > Observe the data traffic easily and perform comprehensive network analysis
- > Conduct robustness tests by stimulating single LRUs or the complete network
- > Simulate entire systems and remaining bus simulations by creating models
- > Simultaneously access CAN, AFDX®, ARINC 429 and digital or analog I/O signals with a single tool

More information, product videos and webinar recordings:

[www.avionics-networking](http://www.avionics-networking)

Attain your goals quickly while maintaining a clear overview – of even complex network architectures. Increase the efficiency of your test integration and accelerate your system validation and verification.





// Flight testing of the CS2 demonstrator will begin before the end of the decade

# Tunnel test for Clean Sky 2 demo helicopter

A mockup of Airbus Helicopters' high-speed, compound helicopter demonstrator currently being built as part of the Clean Sky 2 European research program has undergone windtunnel testing in an Airbus facility. The tests proved the viability of the chosen design in terms of efficiency, sustainability and performance, paving the way for a preliminary design review expected at the end of 2016.

Meanwhile the overall project has passed its first official milestone involving all core partners by reaching the end of its pre-design phase.

Building on the achievements of the company-funded and record-breaking X-3 technology demonstrator, the CS2 demonstrator will help refine the 'compound' aerodynamic configuration and bring it closer to an operational design, with the end objective of meeting future requirements for increased speed, better cost efficiency, and dramatic reductions of emission and acoustic footprints. Flight testing of the prototype is expected to start in 2019.

"Our Clean Sky 2 demonstrator will not only be about going faster. It will help make speed smarter by seeking the best trade-off between cost efficiency, sustainability and mission performance," said Jean-Brice Dumont, Airbus Helicopters Chief Technical Officer. "We want to break the cost barrier usually associated with increased speed and range and pave the way for new missions set for 2030 and beyond by providing crucial emergency or door-to-door transportation services to European citizens where they need it most." \

For regular news updates:

[AEROSPACETESTINGINTERNATIONAL.COM](http://AEROSPACETESTINGINTERNATIONAL.COM)

# Out with the old

A favored saying of safety engineers is, 'There are no new accidents, only new victims'. Does this apply to aerospace testing in the modern era?

**S**uggesting there are 'no new accidents' is a gross simplification and shows a lack of appreciation for the complexity of modern aerospace systems.

In an accident's aftermath, all stakeholders are highly motivated to get answers; however, this is not the same as actually understanding what went wrong. For example, jumping to the conclusion 'pilot error' is a very easy and may superficially explain the sequence of events before an accident.

Consider the case of a military training aircraft flown by a novice pilot, which suffered an undercarriage failure immediately after touchdown. The investigation revealed the undercarriage lever was not set to the 'locked' detent; as far as the investigators were concerned, this was classic pilot error: case closed. However, that did not explain why the same issue occurred on two more occasions shortly afterward, despite changes to the training syllabus to emphasize the importance of locking the undercarriage before touchdown. Further investigation revealed that the touchdown 'bump' (in the hands of a student pilot) was sufficient to cause the undercarriage lever to

leave the 'locked' detent of its own accord – a totally unacceptable design flaw for a training aircraft. The initial assessment of 'pilot error' was completely plausible, and completely wrong. As with the vast majority of accidents, it was in fact a totally new linkage between a hazard, a cause and an outcome.

A positive aspect of accident investigation is that the aerospace testing community is very good at learning from past mistakes – once accurately identified. Once a mitigation is in place and previous accident knowledge has permeated into the testing community's thinking, it is extremely unlikely that it will happen again. This further supports the conjecture that there are, in fact, lots of 'new' accidents, as the causes of the 'old' are being iterated out of existence through mitigation strategies and measures.

It is human nature for previous accident knowledge to steer the investigation of new ones, but it can lead to tempting false conclusions. The challenge is accepting that not all accidents are 'old' accidents, and to avoid the pitfalls of assigning broad terms that give quick answers, but fall short of providing genuine understanding of causes. \\\

## Garnet Ridgway

has a PhD from the UK's University of Liverpool. He has designed cockpit instruments for Airbus and currently works for a leading UK-based aircraft test and evaluation organization



## Sophie Robinson

works at the front line of aerospace testing as a rotary-wing performance and flying qualities engineer for a leading UK-based aircraft test organization. She also holds a PhD in aerospace engineering from the University of Liverpool

**T**he history of accidents in aerospace testing is long and varied, stretching back to the earliest pioneers of aviation and touching the aircraft of the future. Lt Thomas Selfridge was the first person killed in an aviation accident as a passenger during a demonstration of the Wright Flyer II in 1908. Aircraft accidents have become less frequent over time as both the technology available and our understanding of aviation safety have increased, and aerospace testing-related accidents in particular have become a newsworthy rarity; recent fatal incidents involving Virgin Galactic's SpaceShipTwo and the prototype Finmeccanica AW609 tiltrotor made headlines around the world. In between these events, aerospace testing accidents have been numerous; surely, by now, we've seen everything there is to see, and everything that could go wrong, has?

Analysis of causal factors behind aircraft accidents reveals distinct trends in testing for both the civilian and military spheres. The human factor is the largest and most worrisome trend from recent years. Increasingly complex flight systems, aircrew fatigue and inconsistent

training and regulation emerge as constant themes throughout air crash investigations. Evidence of repeated mistakes suggests that not all accidents in testing are new, and that changes to procedure and training are required to further reduce our accident rate. It is unsurprisingly that the same mistakes are repeatedly made within the testing community. We are, after all, trained in similar ways, from similar backgrounds, frequently working on similar projects, so it is not too surprising that similar things go wrong.

If we recognize mistakes are being made, what are we doing to prevent future accidents and further reduce test flying risks? Engineers commonly participate in the 'learning from experience' (LFE) process; both positive and negative issues and experiences during trials are documented. After completed tests, this knowledge is fed to the wider engineering community so that issues can either be mitigated or prevented in future. A positive, proactive safety culture is driving a reduction in testing accidents. As this rate iterates toward zero, a time will come when testing accidents are confined to the history books. \\\



# Q.series

Intelligent Solutions for  
Test Automation and  
Performance Monitoring



## For your data-critical applications:

Validation and Certification of Aircraft Components and Systems, End-of-Line Testing, Structural Health Monitoring.

- Distributed and flexible
- Dynamic signal conditioning up to 100 kHz
- Precise nanosecond time synchronization
- Galvanic isolation of all inputs and outputs
- Repeatable test results due to minimal signal drift
- Open standards support for reliable interoperability

Q.raxx



Q.bloxx



Q.brixx



test.commander





# close encoun



A future for unmanned aircraft systems in the civil airspace will rely on extensive testing to ensure public safety, with NASA's UAS integration in the National Airspace System project leading the way

The air has been humming for some time with promises of a new era in the civil application of unmanned aircraft systems (UAS), with a range of potential roles from fisheries protection, security and border control to agriculture, pipeline and rail inspection, as well as the biggest opportunity of all – the multi-trillion-dollar international air cargo market.

Despite the apparent ubiquity of drones and the technological leaps that have been made in this sphere, that vision of the future remains firmly beyond the horizon, and for good reason: safety. UAS pose a clear danger to other aircraft.

It is possible to fly a drone on one continent and pilot it from another, but generally only in segregated airspace, such as a theater of war. In unsegregated airspace – that used by all other air traffic – the laws governing the flight of drones are highly restrictive. In the UK you are not allowed to fly a drone above 400ft; in the US, the limit is 400ft. If you fly a drone too close to another aircraft, airport or airfield you could be prosecuted; and in the UK, drones must not be flown within 50m of cars, buildings or any other man-made structure. The most fundamental restriction on the use of drones, and the chief barrier to their wider application in civilian airspace, is that they must remain within visual sight of the ground-based operator.

So the question the industry is trying to address, in partnership with the regulatory authorities, is how to develop reliable command and control systems and detect and avoid (DAA) technology to fully integrate UAS into unsegregated airspace? Such a system would require the integration of many technologies, from ground-based and onboard systems to air traffic management software platforms. It would also require a rigorous and extensive testing program.

#### **NETWORK TRIAL AND ERROR**

NASA is leading the development of just such a network to support the integration of UAS into the US air traffic management system – the National Airspace System (NAS). The project has just entered a crucial fourth round of testing that will involve multiple encounters between UAS and a range of piloted aircraft.

Known as the Unmanned Aircraft Systems Integration in the National Airspace System (UAS-NAS),

# ters



**“If done correctly, autonomous operations will change the way the general public use aircraft today”**

1 // NASA's Ikhana UAS soars over the Mojave Desert during a flight from NASA Armstrong Flight Research Center, Edwards, California  
(All photos: NASA)

the project aims to develop the capabilities to overcome the technical barriers related to safety and the operational challenges of enabling routine UAS access to unsegregated airspace. The latest tests will be used to gather data to help develop minimum operational performance standards (MOPS) to enable industry to build aircraft systems that are certifiably capable of avoiding collisions with other manned aircraft.

“The project is focused on four primary technical challenges,” explains Davis Hackenberg, deputy project manager for UAS-NAS at NASA’s Armstrong Flight Research Center. “Detect and avoid, human systems integration, command and control, and integrated test and evaluation. Each technical challenge has specific technologies that must be enabled in order to complete each of these technical challenges.”

Hackenberg says the DAA technologies will include a traffic collision avoidance system (TCAS); sensors to detect aircraft while the UAS is in flight, such as radar;

and algorithms to guide the pilot on suggested maneuvers to avoid incoming traffic. “Each of these technologies will work as a system that will assist the UAS pilot in following the NAS Right of Way rules to ‘see and avoid’ other air traffic.”

**ADDING THE HUMAN FACTOR**

The human system integration part of the project will explore the effect of the human factor in remote operation, with the hope of developing effective ground control station displays that will enable the pilot to perform the DAA function. The command and control element of the program is focused on the aircraft radio and ground infrastructure required to implement reliable terrestrial-based communication systems for UAS to remain in constant communication with their associated ground control stations.

All the systems will be subject to an integrated test and evaluation program, which will involve full-scale

**24**

The number of small UAVs flown simultaneously at different locations in the USA under the management of a single air traffic control platform





2 // An InstantEye unmanned aircraft took part in Coastal Trident 2015, which helped test NASA's UAS Traffic Management System (UTS)

2

flight tests with multiple aircraft. The current target is to build a live, virtual distributed environment to integrate the project's technologies and provide for a scalable relevant test environment. The project will also provide test aircraft with DAA technologies and intruder aircraft with mixed equipment that represent flight operations in the NAS. The team will also aim to develop safe and effective flight test techniques to conduct complex air-to-air DAA encounters.

#### TESTING ROUNDS

The previous rounds of flight tests have consisted of 'fast-time simulations', human-in-the-loop testing and some flight tests to establish that the candidate technologies are viable for the purposes of the project.

"The tests generally focus on stressing various aspects of the technologies in several representative environments of the NAS," continues Hackenberg. "Fast-time simulations generally simulate how a UAS will interact with the new technologies on board the unmanned aircraft as a whole, and can be designed to help understand overall dynamics and impacts on safety when integrating new and potentially disruptive technologies such as UAS into the NAS.

"Human-in-the-loop tests focus on how specific human elements in the system, such as pilots and air traffic controllers, interact with the revolutionary technologies being developed in the project."

Technology testing is an iterative process, adds Hackenberg, but flight testing is usually the final stress and verification test in the technology development cycle. "Flight tests are used to prove technological capabilities in a real-world environment. They involve integrating a system into the flight environment that it will be expected to perform in before it is certifiable."

A fourth round of flight tests began at the end of April (Flight Test Series 4; FT4) and are due to continue until June. NASA Armstrong's Predator B remotely piloted aircraft, Ikhana, will be flown into encounters with a range of 'intruder' aircraft, at high and low speeds. Each of the intruders will be equipped with different systems for operations in the NAS. They will

***"The current performance standards being developed will break down major barriers to UAS integration"***

represent aircraft equipped with cooperative systems such as a transponder, as well as non-cooperative aircraft, which have no communication or detection equipment and will require the Ikhana to use an air-to-air radar to detect and track them.

All the variables of the air-to-air encounters are gathered into a flight test plan, which the team use to coordinate the DAA systems, intruder aircraft equipment and speeds, encounter geometries, and the number of intruder aircraft needed to conduct the encounter.

# When failure is not an option..

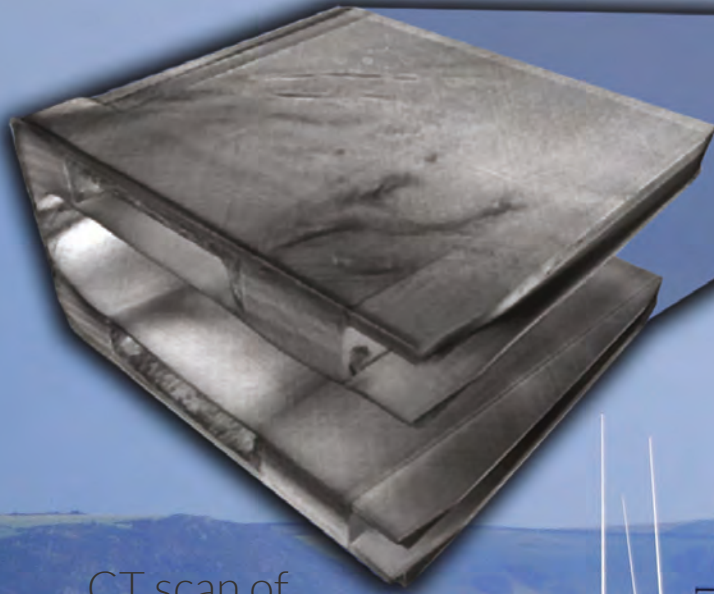

CT scan of  
a Rotor Spar



## Our technology helps eliminate the possibility

We build World Class Industrial Digital X-ray and  
3D Computed Tomography Systems so you can  
develop the world's best products.



4nsi.eu | +33 (0) 1 48 17 02 00 | sales.eu@4nsi.com

Now Open in the UK | 4nsi.eu/uk





3 // Flight Test Series 4 (FT4) saw several piloted aircraft, referred to as intruders, adopt different positions near or around NASA's Ikhana Predator B remotely piloted aircraft

## ***“Industry is moving at an extremely rapid pace, developing technologies that will fly on board UAS”***

Ground tests are carried out prior to the flights themselves to validate software. This is followed by preliminary flights to ensure that all the onboard systems are working and will gather the data required by the researchers. That data will be used to plan future test flights and play an important part in helping to develop the technologies necessary for UAS integration.

### **FT4 GOALS**

Sam Kim, co-project engineer at NASA Armstrong, says that FT4 is taking the lessons learned in previous rounds of testing to continue to reduce the risks of flying UAS in unsegregated airspace.

“FT4 will include 15 flights and more than 270 scripted encounters between the NASA Ikhana and a mix of intruder aircraft,” he says. “These aircraft range from a slow-speed TG-14 motorized glider to a high-speed Gulfstream III. Initial flights will commence with single-intruder encounters and build up to more operationally representative, multi-intruder, complex scenarios including intruders with mixed equipment, i.e. ADS-B mode C only [a satellite positioning broadcast] with no transponder.”



4 // NASA researchers observe one of the FT3 tests from the Research Ground Control Station at NASA Armstrong

Kim says that FT4 will introduce new capabilities and technology refinements, in particular to help validate minimum operational performance standards for DAA. “FT4 results will be used to support validation of the Phase 1 DAA MOPS,” he says. “Additional data collected on the effect of sensor uncertainty and TCAS interoperability will lead to continued DAA algorithm refinements.”

The next stage of the project will be to extend the technologies under investigation to a broader class of UAS, and expand the parameters of the test flights themselves.

### **FURTHER UAS DEVELOPMENTS**

“The current performance standards being developed will break down major barriers to UAS integration, but there is still more to be done,” says Hackenberg. “For example, DAA technologies are currently limited to airborne sensors with higher size, weight, and power [SWaP] requirements than many commercial companies would want for their UAS.”

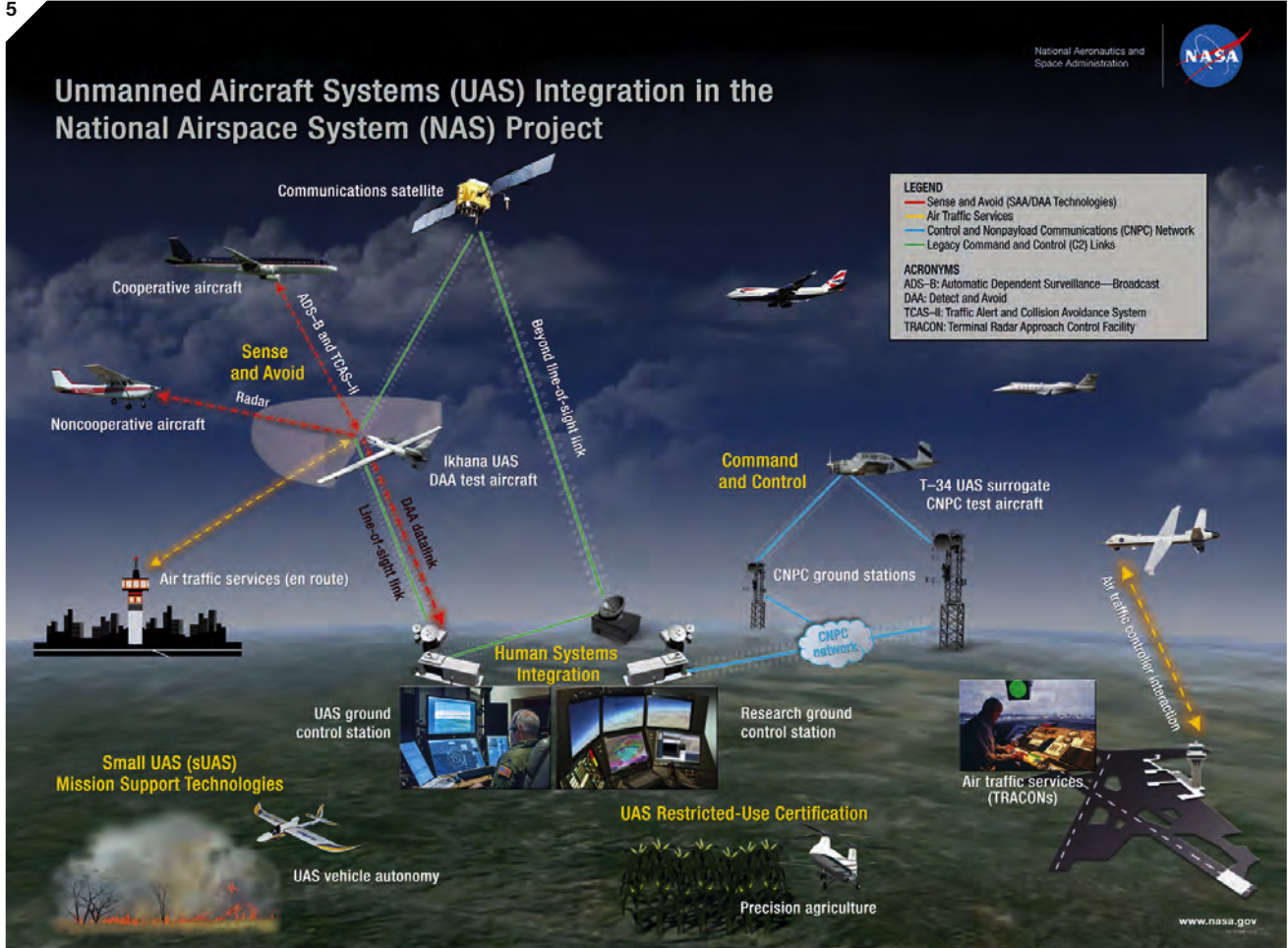

“The next phase of the project will include lower SWaP sensors that should enable a broader market. Airborne DAA technologies also have limitations as to how close to the ground they can function. The project will include ground-based sensor concepts to ensure that a UAS has DAA technologies available that are capable of functioning in all phases of flight.”

The establishment of minimum operational performance standards is an essential step on the pathway to the industry being able to build certifiable UAS technology and aircraft systems capable of integrating into the NAS.

“Without industry standards, there is no way to ensure that UAS will interoperate well in the current airspace system or with each other,” says Hackenberg. “Developing MOPS is an extremely challenging process and requires considerable coordination across industry and government. NASA is the perfect fit to work with both the FAA and industry to develop a standard that can be leveraged by all to integrate UAS into the NAS. The MOPS documents currently in development will be leveraged by the FAA to create the regulations to integrate UAS into the NAS.”

**5 //** NASA is working to assist the FAA in developing regulations to integrate Unmanned Aircraft Systems into the National Airspace System

**FULL INTEGRATION**

The long-term goal, however, notes Hackenberg is full UAS integration: “The phrase ‘full UAS integration’ may sound like a cliché, because even manned aircraft are not fully integrated today, but NASA will focus on strategic areas to contribute to, to ensure commercial markets are opening up for all the industry, and that it is being done in a manner that is safe and acceptable to the FAA.

“Industry is moving at an extremely rapid pace, developing technologies that will fly on board UAS and assist in integration with the current FAA air traffic management system. NASA is constantly looking for strategic partnerships that keep the country at the leading edge of this revolutionary technology. In the long term, the NASA vision includes UAS and other aircraft operating autonomously in the NAS. If done correctly, autonomous operations will change the way the general public use aircraft today, and make our airspace safer for all to use.” \

**400FT**

The maximum height to which a drone can be flown in unsegregated airspace in the USA

**270**

The number of scripted encounters between NASA's Predator B drone and manned aircraft, in which NASA will test its detect-and-avoid systems





IMV VIBRATION  
TEST SYSTEMS  
**Aseries**

# A-series launched

A-series defines the standard for vibration testing.

## IMV CORPORATION launches the world-leading A-Class Shaker Range in Europe.

- All new air-cooled design
- Maximum force rating of 65 kN, sine and random
- Shock velocity rating of 3.5 m/s
- Standard displacement of 76.2 mm
- High strength and reliability
- Extended high frequency range
- Designed for a greener environment with reduced power consumption (20 % higher kN/kVA)
- Including IMV's fully automatic eco-technology ([www.eco-shaker.com](http://www.eco-shaker.com))



**IMV CORPORATION**

**Head Office (Japan)**  
[kaigai-1@imv.co.jp](mailto:kaigai-1@imv.co.jp)

**IMV America, Inc.**  
[info@imv-usa.us](mailto:info@imv-usa.us)

**IMV EUROPE LIMITED (UK)**  
[info@imv-tec.com](mailto:info@imv-tec.com)

**IMV (THAILAND) CO., LTD.**  
[service@imv.co.th](mailto:service@imv.co.th)

**IMV EUROPE LIMITED (Germany)**  
[martin.engelke@imv-tec.com](mailto:martin.engelke@imv-tec.com)

**IMV CORPORATION  
Shanghai Representative Office**  
[kaigai-1@imv.co.jp](mailto:kaigai-1@imv.co.jp)

Although a small air arm, the Finnish Air Force boasts an established operational test and evaluation unit to validate and verify its test programs, chief of which concerns ongoing work to extend the service life – and capabilities – of the F/A-18 Hornet

# Flying



1 // The Finnish Air Force is currently engaged in completing a mid-life upgrade (MLU) program for its entire F-18 fleet, with work scheduled to finish this year  
(All photos: Derek Bower)

# Finns



R

eporting directly to the Finnish Air Force, the Finnish Air Combat Centre (ACC)

operates from the air base of Pirkkala, southwest of the city of Tampere in southern Finland. The ACC has been at its current home since 2013, when a reshuffle within the Air Force saw the former Flight Test Centre moved from Halli and reconstituted at Pirkkala under its new title.

Employing a cadre of qualified test pilots (TPs) and flight test engineers (FTEs), the role of the ACC is to evaluate and clear for production airframe and software modifications on behalf of the Air Force. As a result, it is especially busy during aircraft upgrade programs. Currently the most important of these is the mid-life update (MLU) for the Finnish Air Force's front-line fleet of 62 Boeing F/A-18C/D Hornet fighters.

## FINNISH AIR FORCE WEAPONS TESTING

A pair of Finnish Air Force F/A-18C Hornets arrived at China Lake, California on April 15 after a long transit. Boeing F/A-18C HN410 and HN419 (callsigns Finnish Air Force 157 and 158 respectively) flew along with Omega Air Refueling Service's sole Douglas KDC-10-40 tanker N974VV (c/n 46974/274), which uses callsign Omega 10. The tanker arrived at Tampere-Pirkkala Airport (TMP/EFTP) in Finland on April 9 to start workups with the Finnish F/A-18 pilots in preparation for the overseas flight. The transit from Finland flew via Reykavik (KEF) on April 12, on to Goose Bay (CYR) on the 13<sup>th</sup>, CFB Trenton (CYTR) then to Scott AFB, Illinois (KBLV) on the 14<sup>th</sup>, then to Peterson AFB, Colorado, (KCOS) and ultimately to Naval Air Station China Lake, California (KNID) on the 15<sup>th</sup>.

The Finnish Air Force has previously used the Naval Air Warfare Center Weapons Division facilities at NAS

China Lake in California for weapons testing, most recently on the Lockheed Martin AGM-158 Joint Air-to-Surface Standoff Missile (JASSM) trials for the Finnish F/A-18C/D fleet. The Hornets are operated by the Air Combat Centre (IlmataiSteluKeskus - IlmaStK) of the Aircraft and Weapon Systems Training Wing at Tampere-Pirkkala, and appropriately HN419 wears an X (for experimental) marking on the tail with KOELNTK on one of the arms of the X. Finnish Air Force F/A-18C/Ds also recently completed an aerial refueling training exercise with a US Air Force 100<sup>th</sup> Air Refueling Wing KC-135 from RAF Mildenhall, between April 4-8, 2016.

Omega Air has been providing air-to-air refueling for US and allied air arms since 2000, using Boeing KC-707s and McDonnell Douglas KDC-10s. The KDC-10 is equipped with a Cobham dual-hose probe and drogue configuration.

2 // Ground crew load AIM-120 AMRAAM missiles on a single-seat F/A-18C



2



## “Four aircraft were selected for development testing of the new modifications”

3 // 'X' for experimental: the marking of the Air Combat Centre on the Hornet's tail. KOELNTK is the Aircraft and Weapon Systems Training Wing

4 // The Air Combat Centre is known in Finnish as the IlmataisteluKeskus

5 // Ground test fit of the JDAM

integrate the air-to-ground capability began in the late 1990s and continued on to 2001.” In 2004 the Air Force received the go-ahead to pursue MLU2 as a rolling program of upgrades. The ACC is a key local player in what is a multinational effort, involving manufacturer Boeing, the US Navy, and Finnish aerospace firm Patria, which undertakes the MLU2 modification work at its Halli facility in central Finland.

The MLU2 package includes new weapons in the form of the 2,000 lb (907kg) GBU-31(V)1/(V)3, the 1,000 lb (454kg) GBU-32, and the 500 lb (227kg)

GBU-38 variants of the Joint Direct Attack Munition (JDAM). A stand-off precision-attack capability is being introduced by the Raytheon AGM-154C Joint Stand-Off Weapon (JSOW). Furthermore, MLU2 includes upgrades to the mission systems, computers and associated software, a new radar warning receiver, AN/AAQ-28 Litening AT targeting pod, and the Multifunctional Information Distribution (MIDS) Link 16 system.

Since the air-to-ground role represented uncharted territory for the Air Force, the ACC first sent a team of TPs and FTEs to Boeing's facility in St. Louis, Missouri, where they took part in ground academics and flew simulated strike sorties in Hornet simulators. Meanwhile, back in Finland, four aircraft were selected for development testing of the new modifications. Two Hornets received 'orange-wire' wiring harnesses to develop the new weapons release software and to integrate the newly installed and modified avionics with the new mission computer software. The other two were to serve as verification and validation airframes for the modifications.

After the initial installations had been verified, the orange-wired airframes were rewired with production-standard MLU2 harnesses. All four airframes have since been reworked to MLU2 production standard and have been returned to front-line service.

### SOFTWARE GLITCHES

The development aircraft began flight tests in September 2009 with an initial brief to verify compatibility and mutual integration of all the new components. Mission computer software crashes leading to display malfunctions were an

2

F-18Cs lost in accidents, to date. Finland originally purchased 57 single-seat F-18C Hornets and seven two-seat F-18D models

26-36

People on the test flight team: 1 chief test pilot, 7 test pilots, 8 flight-test engineers and 10-20 engineers/avionics specialists



3



4

5



The importance of monitoring Hornet modernization work – the current program is the so-called MLU2 upgrade – is reflected in the fact that the ACC has four of its seven test pilots dedicated to it. Chief test pilot Lt Col. Saku Joukas is the longest-serving TP in the ACC, with over 2,800 hours flying time including 1,500 on the Hornet.

### INTEGRAL ROLE

A veteran of both the MLU1 and MLU2 programs, Joukas confirms that neither of these far-reaching upgrade initiatives could have taken place without the ACC's efforts. MLU1, completed in 2010, was primarily concerned with improving the Hornet's air-to-air capability. MLU2 is now bestowing the jets with a new air-to-ground capability, which has seen their designation change from F-18 to F/A-18 – for Fighter/Attack.

As Col. Juha-Pekka Keränen, commanding officer of Pirkkala air base and the ACC, explains, “Studies to

# Integrated Vibration Control and Analysis in a Compact Package

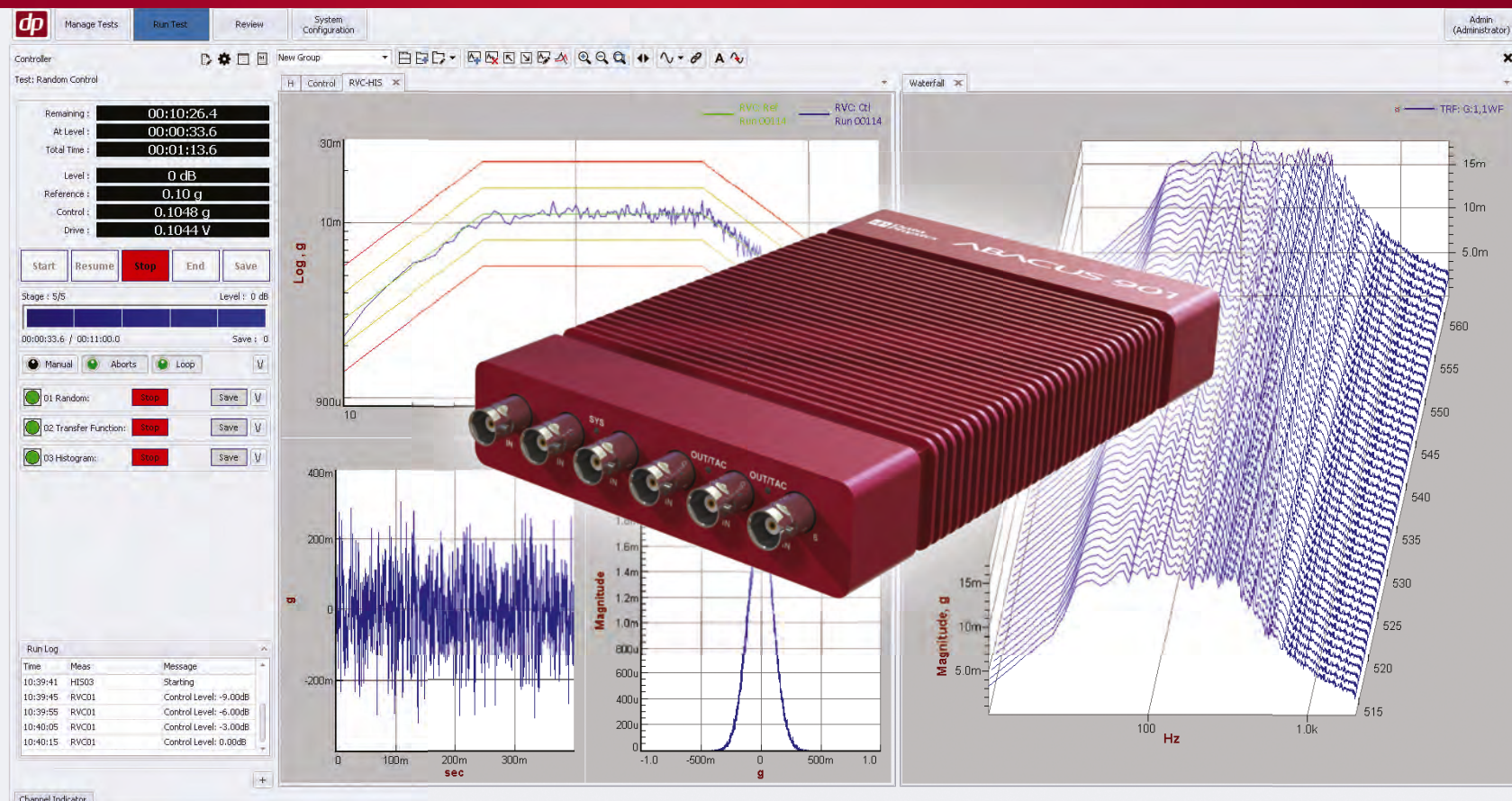

## The New Data Physics Abacus 901 Vibration Controller.

The release of the controller software for SignalCalc Test Suite adds affordable, high performance vibration control to the Data Physics 900 Series hardware platform. The SignalCalc Test Suite provides a seamless environment for simultaneous vibration control and signal analysis. The new SignalCalc 900 Series software has a unique ability to add signal analysis measurements to a vibration control test. Signal analysis measurements are immediately available, removing the delay of waiting for post processing of recorded data.

- Random Vibration Control
- Sine Vibration Control
- Shock Vibration Control
- General FFT Analysis
- Data Acquisition and Recording
- Structural Analysis

A member of the  
**N|V|T) GROUP**

**dp** **Data  
Physics**





6 // Finland eventually plans to replace its existing F/A-18C/D Hornet fleet, which will be phased out by 2025

early problem to be overcome. Here, the ACC collaborated with both Patria and the US Navy Advanced Weapons Laboratory (AWL) at China Lake, California, and FTEs and avionics experts worked together to iron out the software flaws.

By August 2012, testing had confirmed that the software could be released to service and at this time it was incorporated into MLU2 production aircraft as System Configuration Set SCS-23X(F). However, the ACC has continued to test further enhancements and since last summer, MLU2 aircraft leaving the Patria facility have been equipped with SCS-25X(F). The ACC is now working toward proving software standard SCS-27C(F), which represents full operational capability.

7 // A ground test fit of the JASSM, which is expected to enter service with the Finnish Air Force in 2017

Once the ACC had begun to demonstrate the new systems under the SCS-23X(F) standard, weapons testing could begin. Simulated ground-release trials using inert weapons that took place in 2010 were followed by captive carriage flights that lasted until summer 2015. These flights took place concurrently with developmental testing of air-to-ground software. By June 2015, the ACC was ready to begin live-fire testing of JDAMs.

In fact, the scope and extent of computer simulations and simulated ground-release tests of inert GBU-38 Glide Test Vehicles (GTVs) were such that only a single air drop with an inert GBU-38 GTV was required to prove the software. As Lt Col. Joukas explained, the result of this test matched data obtained from China Lake and led to the decision to move to live drops with explosive munitions.

#### GOING LIVE

In June 2015 the ACC, operating as a detachment at Rovaniemi air base, conducted four live drops over the

## ACC TEST PILOT REQUIREMENTS

"To qualify as a TP for the Finnish Air Force, an individual must be a graduate of any of the accredited test pilot schools around the world," explains Lt Col. Saku Joukas. "They must have at least 800 hours flying in their logbook, of which 400 must be on the Hornet. The minimum operational experience level is two-ship lead, but preferably four-ship."

The demanding work means that a TP's career with the ACC can be short and intense. "With the ACC they can expect to fly around 10-15 hours per month and in total around 150-200 hours each year. Currently, although tasked with various administration duties, I still fly an average of 100+ hours per year, either on the Hornet or the Hawk trainer development programs. In percentage terms it's 80% on Hornets and 20% on Hawks."

For Joukas, one aspect above all is required for a successful TP: "The ability to carry out full and honest appraisal of his or her actions." Among Joukas's roles is selection of new TPs for the ACC. Once accepted, TPs and FTEs will undergo constant flying training to ensure the required test results for whatever program they are conducting. All TPs are qualified to fly any aircraft in the Air Force inventory, including the Hornet, the Hawk, the Vinka primary trainer and various transports.

8 // Chief test pilot Lt Col. Saku Joukas has clocked over 2,800 hours' flying time in total, including 1,500 on the Hornet



30+

Types of aircraft that chief test pilot Lt Col. Saku Joukas has flown in his nine years as a test pilot

590

ACC staff: 340 full-time personnel and around 250 conscripts



9 // Col. Juha-Pekka Keränen, commanding officer of Pirkkala air base and the ACC

Rovajarvi weapons range in Lapland, reducing flying time to the range from 45 minutes to just five minutes. In the course of five days, the ACC completed four live drops of two GBU-38s, one GBU-32 and one GBU-31(V)1. Successful results meant that a release to service could be issued the same month – this initial operating capability marking the first clearance for the Finnish Hornets in their air-to-ground role.

Now that MLU2 work is in full swing, and aircraft have been returned to front-line service, the ACC's work involves operational pilots (OPs) embedded in the test unit at Pirkkala. These act as intermediary instructors, providing briefings to the operational squadrons, and flying with squadron instructor pilots

(IPs) to check they are fully up to speed on MLU2 capabilities. At the same time, the OPs are writing the required MLU2 amendments to be added to Air Force operational procedures, and tactics, techniques and procedures manuals.

The forthcoming SCS-27C(F) software drop for the MLU2 program will see the introduction of the AGM-158 JASSM. Initially the JASSM flight test equipment and captive 'inert' missiles are at the China Lake test facility. This year, MLU2 Hornets and test pilots, supported by mechanics and specialist technicians, will go to the USA to begin flight trials. If the test results are as expected, and once the SCS-27C(F) software upgrade is successfully introduced, the JASSM is expected to enter service in 2017.

The ongoing work of the ACC in the MLU2 program is a demonstration of how a small test unit can work side-by-side with industry and other testing organizations to realize a step-change in the capabilities of an air force. For Col. Keränen, "MLU2 has enhanced the country's capability to defend itself, and should the Finnish government be asked to contribute air power to NATO or the European Union, the Finnish Air Force is now more able to provide a meaningful contribution in a more capable, effective and precise way."

What would Lt Col. Joukas do differently if he could start the MLU2 test work afresh? "I would like the TPs to leave the FTEs to have much more responsibility and authority in planning, leading and running the projects as we now do today, and not try to oversee everything as we TPs did at the beginning of the MLU2 program." \

## HORNET OPERATIONAL LOAD PROGRAM

While Finland recently launched a program – known as Project HX – to select and procure its next fighter, the Hornet will have to fly on until its stipulated out-of-service date (OSD) of 2030. Compounding this challenge is the fact that the Finnish Hornet fleet's fatigue life expended-index (FLE) usage rate has been much higher than most other F/A-18 users, due to heavy use in the early years (this has now been reduced by almost a third).

Alongside the MLU1 and MLU2 programs, therefore, the Finnish Air Force is studying the best way to ensure the Hornet will achieve this lifespan. "At first, data and software for structural monitoring were obtained from the US manufacturer of the Hornet fighters,"

explains the Air Force's Major Riku Lahtinen. "However, it soon became clear that solid domestic expertise was required."

In order to better determine airframe fatigue life, Patria has developed the Hornet Operational Loads Program. During this program, two F-18Cs were fitted with around 35 load transducers to provide stress indication figures to engineers. By mid-2015, the two jets had recorded over 1,000 flying hours each. This data has been combined with the results of stress modeling, indicating that the airframes are set to reach their expected 4,500 hours fatigue life without further airframe work. This will take the Hornet to its OSD of 2030.



# m+p Analyzer

Noise and vibration testing, analysis and reporting capabilities for aerospace engineering.

New generation of m+p Analyzer provides you with even greater productivity and ease of use:

- Comprehensive measurement, analysis and reporting in one package
- 64-bit performance for Windows 7 and 10
- Integral database structure for quick access to large data sets
- Data comparison and exchange across multiple projects
- High-speed online displays for high channel counts
- Flexible hardware support from m+p and National Instruments

Our products combine convenience, flexibility and efficiency with training, consultancy and support to ensure successful outcomes for all your NVH applications. From gathering simple time history data to structural dynamics, ground vibration, rotating machinery and acoustics testing.



Modal analysis

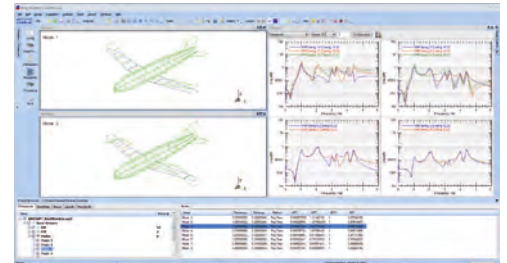

Rotational dynamics

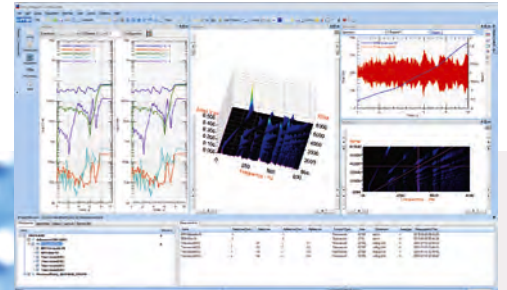

Acoustics & noise refinement

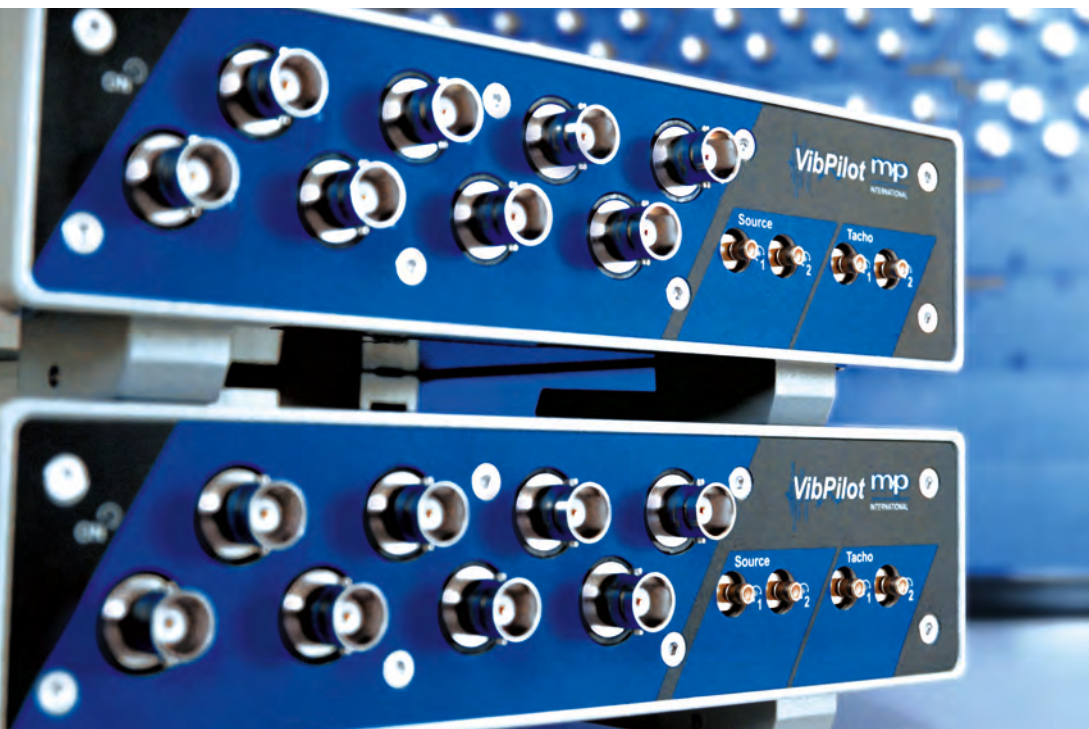
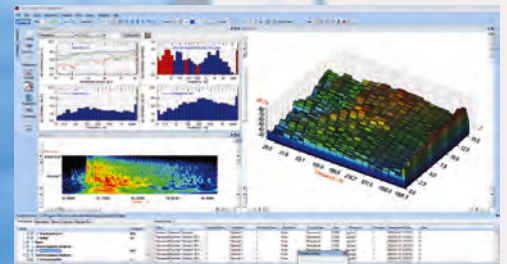



# Underp



General Electric has built a test cell capable of generating airflow at 1,000psi and 1,500°F, while the Engine Alliance has been busy throwing specially engineered sand into an upgraded GP7200

B

oeing is determined that the forthcoming 777X will be the "most efficient twin-engine jet in the world" – given recent strides in large-twin fuel efficiency made by the A350 and its own 787, the company has set its 777X bar high. The aircraft's new wing and aerodynamic improvements will make important contributions to fuel efficiency, but Boeing is relying heavily on GE Aviation, its sole-

source engine supplier, to deliver the rest.

Building on the proven technologies of its GE90 and GENx, GE Aviation is creating the GE9X, which promises a 10% improvement in specific fuel consumption (SFC) compared with the GE90-115B powering the current 777-300ER and a 5% better SFC than any other engine in its class in 2020. In revisiting its GE90/GENx technologies, GE is refining and optimizing every aspect of the new engine, but identifies six key drivers for its efficiency.

New materials, aerodynamics and construction techniques have revolutionized the GE9X high-pressure turbine, composite fan blades and compressor, while additive manufacturing processes and ceramic matrix composites (CMCs) are helping to deliver lower weights and higher temperature capabilities. Finally, GE has

continued to improve its twin annular pre-mixing swirler (TAPS) combustor technology with the GE9X's TAPS III.

In delivering fuel efficiency and reduced emissions, the GE9X will run at a compressor pressure ratio of 27:1, the highest yet achieved in a commercial engine. It will also see temperatures previously reached only in military powerplants and generate inlet conditions more extreme than those of current-generation turbofans.

#### 20/20 VISION

Separate, comprehensive test and maturation efforts are supporting the engine's new technologies and in late 2015 GE began trials in a new US\$100m facility in Evendale, Ohio, specifically built to test the TAPS III combustor. Simply called Cell A20, the building's 200ft stainless steel exhaust stack makes it easy to recognize.

Scott Whitford managed the construction of the facility and explains that although the GE9X is its first test subject, it will have continuing application to other high pressure-ratio products: "The engine has an overall pressure ratio of 60:1, the highest ever for a commercial engine and one never before reached in a commercial engine test. The high temperatures at the combustor inlet are a function of this compression ratio.

# ressure

**Aerodynamics is a decisive factor.  
Count on our testing expertise.**



Put us to  
the test!



RUAG Schweiz AG | **RUAG Aviation**  
Aerodynamics | 6032 Emmen | Switzerland  
Phone +41 41 268 38 01 | aerodynamics@ruag.com  
[www.ruag.com/aerodynamics](http://www.ruag.com/aerodynamics)

**Together  
ahead. RUAG**

**C.E.R.T.I.A**

[www.certia.fr](http://www.certia.fr)

**M. Laurent DANJAN (Europe)**  
+33 (0)1 43 00 90 20 / +33 (0)6 59 81 29 74  
+33 (0)1 43 00 79 80  
[ldanjan@certia.fr](mailto:ldanjan@certia.fr)

**M. Hicham MOKHTARI (Asia / Africa)**  
+213 (0)21 50 60 07 / +213 (0)5 61 69 51 24  
+213 (0)21 50 60 07  
[hmokhtari\\_rd@certia.fr](mailto:hmokhtari_rd@certia.fr)

**M. Franck THELOT (Americas)**  
+33 (0)1 43 00 00 66 /  
+33 (0)1 43 00 79 80  
[fthelot@certia.fr](mailto:fthelot@certia.fr)





“The facility consists of three boost compressors that receive 600psi compressed air from another part of the plant. Each is capable of delivering around 57 lb/s of flow, with the three combined delivering around 160 lb/s to the cell, sufficient for a sector test. It would be impractical to build a facility large enough to recreate the mass flow experienced by a complete combustor in flight.”

The compressors take the air up to 1,100psi at 500°F, before it passes through a series of heaters. These are arranged in two series, the first being gas heaters that burn natural gas and increase the temperature of the air to 1,200°F.

“The second stage comprises 11 electric heaters and we scale the number used based on the test conditions we want to achieve and whether we’re doing single-cup or sector testing. By the time the air reaches the electric heaters it has lost about 100°F, but they heat it to more than 1,500°F. This high-pressure, high-temperature air is then introduced into the cell, direct to the combustor test article.”

Individual test cycles can last for as long as 16 hours and typically involve five to 10 people running the compressor facility, while A20’s control room includes a monitoring room capable of accommodating up to 30 engineers. They examine, review and gather data from multiple sources in real time during a test, while all data

**3**  
Number of 4,500hp  
boost compressors  
at GE’s A20 facility

**11**  
1MW electric heaters  
available

**“The GE9X will run at a compressor pressure ratio of 27:1, the highest yet achieved in a commercial engine”**

## TAPS III

TAPS technology is already employed on the GEnx and CFM International LEAP engines. Compared with conventional systems, it mixes air and fuel prior to combustion for, according to GE Aviation, “a leaner burn and fewer emissions”.

The additional air in the mix lowers emissions, and in its GE9X application TAPS will give the engine a 30% margin to the ICAO CAEP/8 standard for NOx emissions.

The TAPS III combustor has been engineered for this difficult environment, featuring, according to company information, “fuel nozzle tips manufactured using additive technology, along with a new combustor dome design and CMC inner and outer liners, which improve durability and require less cooling air to enhance the lean-burn combustion process”.

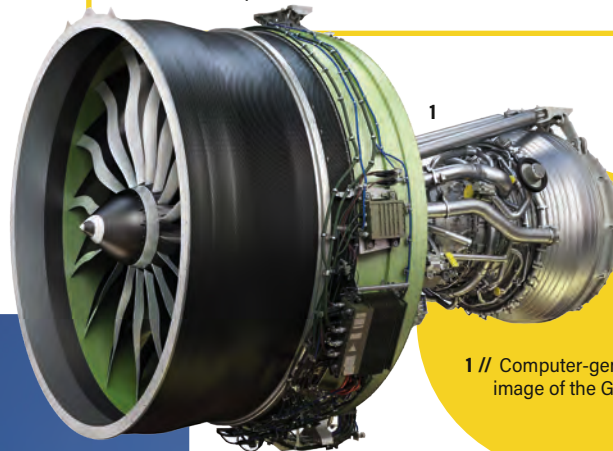

1 // Computer-generated image of the GE9X

is also stored for subsequent analysis. “When we test we’re looking at key combustor performance indication parameters, including emissions, the stoichiometrics of the combustion, and air and metal temperatures.”

A20 includes two cells, one for single-cup and the other for sector testing: “A combustor has many fuel nozzles and a single-cup test takes just one as the test article,” explains Whitford. “A sector test

includes a section of nozzles, so for example a 25% sector test on a 20-nozzle combustor would include five nozzles. The largest sector we test is less than half the total number of fuel nozzles in the GE9X.”

The facility is equipped with two independent fuel systems enabling work with different types of jet fuel. “We currently test with Jet A and a formulation known as C10-12. We could adapt the fuel systems for tests with any fuel, including biofuel, supporting trials for subsequent GE9X and other developments even when the engine is in service on the 777X.”

Describing a typical test anatomy, Whitford says, “We install a highly instrumented test article in the cell, then begin flowing air through it without it being fired, just to check that everything is hooked up correctly. Fired

2 // GE Aviation’s new US\$100m A20 combustor test cell facility and its trademark steel exhaust stacks





**TELETRONICS**  
TECHNOLOGY CORPORATION

# AIRBORNE NETWORK-BASED ACQUISITION SYSTEMS

[sales@ttcdas.com](mailto:sales@ttcdas.com)  
[www.ttcdas.com](http://www.ttcdas.com)  
267.352.2098

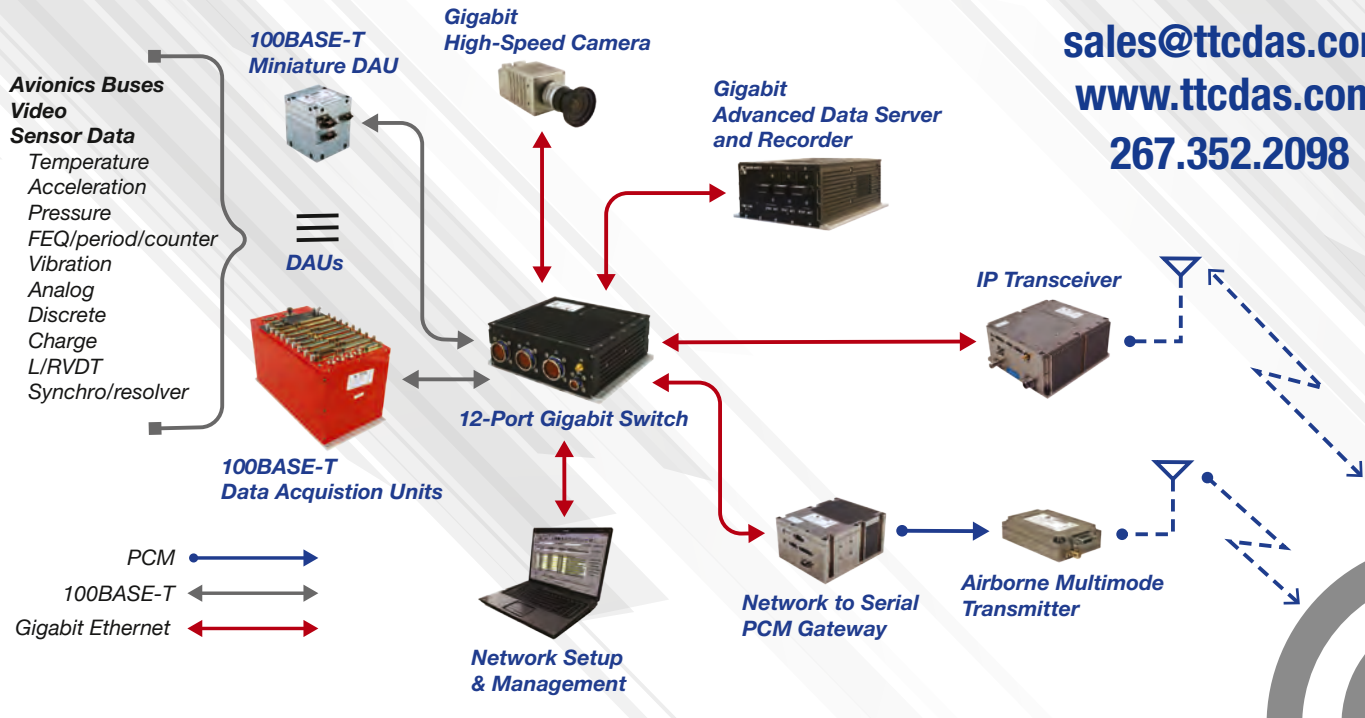

## Equipment. Testing. Support.



Test Smarter.

*The smartest mix for high performance and safety.*

[WWW.LINKENG.COM](http://WWW.LINKENG.COM)



Custom Solutions



Control & Acquisition



Brakes



Wheel End



Springs



Servo Hydraulics



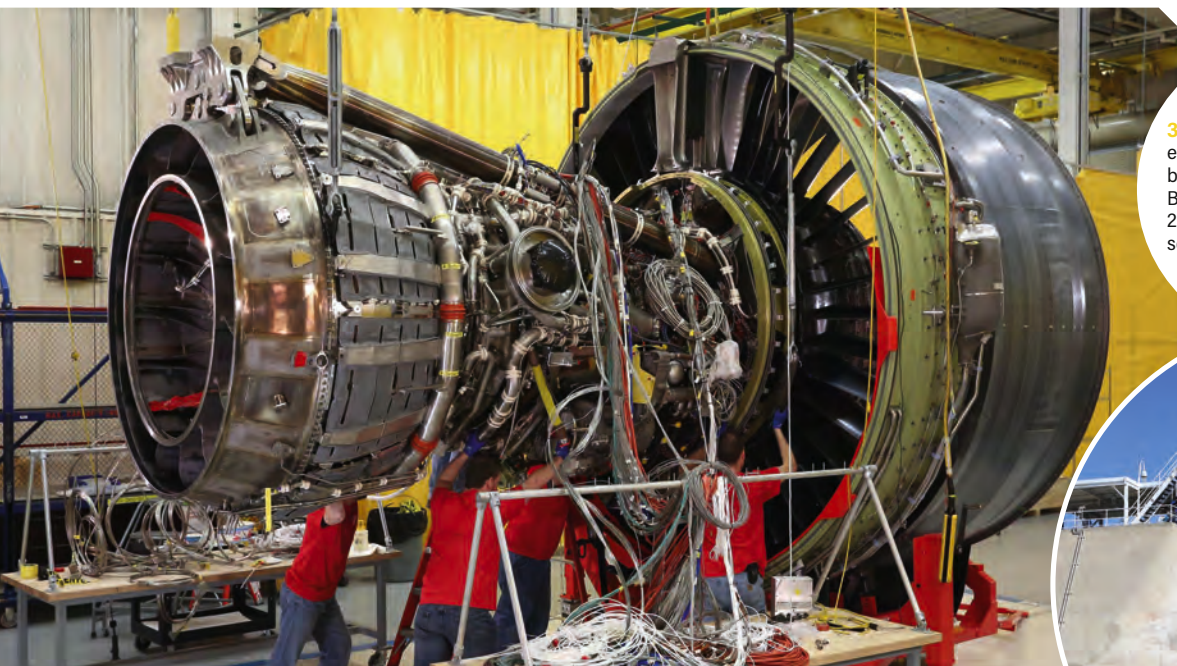

3

3 // The first GE9X test engine – flight testing will begin on GE's dedicated Boeing 747 flying testbed in 2017, with FAA certification scheduled for 2018



4

4 // Ground test of the first full GE9X development engine at GE's Peebles Test Site in Ohio

## “We do high temperature/pressure, acoustic and emissions testing”

testing might follow, according to a test plan describing a matrix of test points for given mass flows, temperatures and pressures.

“Depending on the particular requirement, once a test point is achieved it might be held for a couple of minutes, or it could run for several hours. We do high temperature/pressure, acoustic and emissions testing, featuring highly complex test plans developed by our engineering teams and run by the cell technicians.”

The data gathered depends on the test article instrumentation, but the cell itself is also instrumented and the characteristics of the air reaching the test article are carefully recorded for comparison with the air that has passed through it. The exhausted air is released via the 200ft chimney.

Operational conditions inside the cell are extreme, in keeping with the demands the GE9X places on its combustor technologies. “It’s extremely hot and very noisy,” says Whitford. It would seem reasonable then to expect A20 to be far from population centers, but this is not the case. “We went to great pains to apply acoustic treatments to the facility and its sound emissions meet all regulations. We wanted to be good neighbors in the community and we’ve been pleased by how quiet it is outside when the cell is running. It’s surrounded by concrete walls several feet thick and has huge metal doors, for safety as well as sound-proofing.” The likelihood of a mishap is remote, but GE Aviation has

built the facility with safety in mind since, as Whitford notes, running a test at 1,500°F and 1,000psi generates “a lot of energy”.

### SAND INGESTION

GE Aviation and Pratt & Whitney work closely and share test data on the GP7200 turbofan manufactured by their Engine Alliance joint venture exclusively for the Airbus A380. Employing technologies derived from those of the GE90 and PW4090, the GP7200 has been subject to a high-pressure turbine (HPT) durability improvement program directed particularly at operators in the sandy conditions of the Middle East.

The associated trials effort gathered a mass of data on how the GP7200 will mature in service and, perhaps inevitably, included sand-ingestion testing, which is not a certification requirement and therefore somewhat unusual.

Dean Athans, Engine Alliance president, explains the test program: “I’ve been responsible for the GP7200 since March 2013, when we designed an upgrade to make our hot section more durable. We introduced it into production in 2014 and last year ran a planned 2,500-cycle endurance engine test – with an extra 100 cycles before we pulled the engine out of the cell.

## 1,009PSI

The record maximum pressure achieved

## 20,000FT<sup>2</sup>

A20 facility size

5 // The GP7200 is a popular choice for Middle Eastern operators of the A380, including Emirates and Etihad

"Any endurance engine includes old, original hardware that we're trying to accumulate high cycles on so that we can get a good look at what a high-cycle engine looks like before our customers see it. We also include a lot of repairs that we've developed, so we can get feedback on those in the high-cycle environment. In this most recent test, completed in 2015, we also included our entire durability upgrade HPT, so we could find out how it would do in a severe operating environment, because a large percentage of our fleet flies out of Abu Dhabi, Dubai and Doha. In conducting the tests, we did two unique things. First, we used a cell with the capability to moderately heat the inlet, and second, we introduced sand ingestion."

The inlet heating was insufficient to replicate desert heat alone, but combined with the test engine cycles, which typically lasted around five minutes each and tended to be 'hotter and harder' than those in service, it adequately simulated regional conditions.

For the sand ingestion trials, Engine Alliance used a proprietary GE Aviation rig. It releases sand and dust directly into the inlet, and considerable care was taken to ensure the process was as close to real-life conditions as possible. "Our engineers analyzed the matter that's found several hundred feet up in the air in the Middle East, and the deposits we see in sections of the engine, and engineered sand for the tests. We looked at its chemical composition and replicated that chemistry, as well as the particle size and distribution in our dust.

"In the trials we began accumulating cycles and gathering data on a few specific pieces of hardware. We also did certification testing on a new oil and once we'd established that the engine was stable and working well, about halfway through the program, we began ingesting the sand. We tend to shut these endurance engines down regularly - maybe once a week - and inspect everything with a borescope to confirm we're seeing what we expect and there are no problems. In this case we saw the sand accumulating exactly as expected. Compressor aerofoils, for example, tend to attract sand and dust that sticks, affecting their aerodynamic properties and reducing efficiency. As a result, we've developed procedures using heated water to wash them."

The rationale for endurance testing is that if anything is going to break or wear it should do so on the test stand so that a fix can be engineered long before it is required

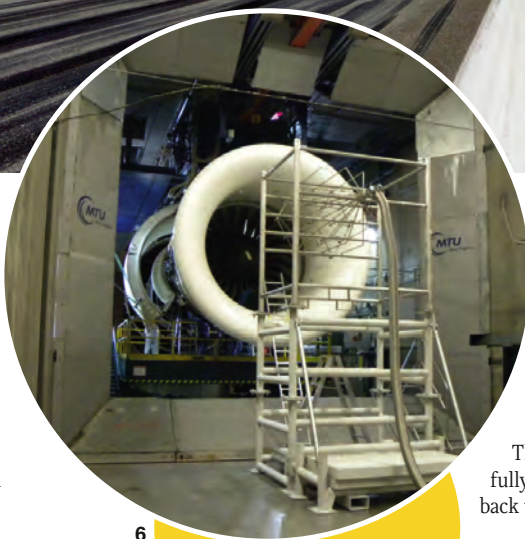

6 // The sand ingestion trials use a proprietary GE Aviation test rig

on an aircraft. In respect of the durability HPT program, Athans reports, "Failures often cause you to stop the test before all the cycles are done, but this endurance run was fully successful. We had no issues, ran every cycle we intended and had sufficient time at the end to run another 100 cycles if that had been needed. The engine has since gone back to the shop, been fully disassembled, and its modules have been sent back to the design engineers for analysis."

### VIRTUAL LAYOUT

In addition to testing the durability of the HPT upgrade and predicting future engine behavior, Engine Alliance gathers data to share with its customers, helping them check for signs of regular, expected wear, as well as anything out of the ordinary.

"Sometimes we'll tear an engine down and label the parts, then invite the customers in to examine all the components," says Athans. "But it can be tough bringing people in from Korea, the Middle East and Europe to see our physical layouts in Cincinnati and Hartford.

"So this time we're planning to do a virtual layout that will be available online, where our design engineers and expert 'module owners' present and describe what we found during the endurance trial. It will also enable us to explain particular endurance characteristics and how they performed, helping us give customers confidence and expectations relative to their own equipment."

Athans confirms that customers will see no signs of the issues related to sand ingestion on entry into service-configuration engines. "We developed the durability HPT specifically to address those issues and ran the tests to ensure that our engineers had done the job well. The areas where we'd seen oxidation, burning or cracking looked much, much better, showing none of those characteristics. We'd simulated twice as much heat distress and seen almost no deterioration in the engine hardware." //





# Tightly Integrated, Truly Synchronized



With the introduction of new MTS FlexDAC™ Data Acquisition Systems, MTS now provides the aerospace industry's only truly synchronized control and data acquisition solution, completely eliminating data skew from test data. You can now spend more time analyzing results than questioning their accuracy.

From state-of-the-art controls and data acquisition to reliable hydraulic power generation and distribution through world-class service and support, only MTS makes it all available from a single, proven global provider.

Contact us today to learn how integrated, synchronized MTS solutions can help you achieve the highest levels of accuracy, efficiency and safety for your aerospace structural test programs.



MTS FlexDAC data acquisition systems, FlexTest® controllers and AeroPro™ software: the only truly synchronized structural test solution in the industry.

[www.mts.com](http://www.mts.com)  
[info@mts.com](mailto:info@mts.com)  
Tel: +1.952.937.4000

©2016 MTS Systems Corporation.  
MTS and FlexTest are registered trademarks and MTS FlexDAC and AeroPro are trademarks of MTS Systems Corporation. These trademarks may be protected in other countries. RTM No. 211177.

MTS AEROSPACE SOLUTIONS  
be certain.

# MI



1 // F/A-18A/B  
Hornet flight test aircraft  
from the RAAF's Aircraft  
Research and  
Development Unit (ARDU)



# FTI

The Australian Defence Force's Air Warfare Centre has developed a non-intrusive flight test instrumentation solution to flight testing

# no-wires





# Fast & Secure DATA LOADING

A615A | A615•3 | A603

PDL Mk.II



PDL Mk.III



PDL Mk.IV



All PDL models available  
with GARDT® technology



- Certified by Airbus, recommended by Boeing, and used by airlines and MROs worldwide
- Support of all LRU loads on any civil aircraft
- Airbus compliant secure data loading with TechSAT's patented GARDT® technology
- Operable under extreme environmental conditions (e.g. high temperature)
- Easy solution for MDDU replacement with connector plate
- Interface to any FLS management system (eESM, AMOS, TechSAT Sync software)

## PDL Software Options:

A615A NetLoader • AFDX® NetLoader  
CAN Data Loader • A665 MediaCreator  
FAL Loader

RECOMMENDED  
BY  
BOEING

AIRBUS  
CERTIFIED

[www.techsat.com](http://www.techsat.com)





# U

nder the auspices of the newly formed Air Warfare Centre (AWC) the Australian Defence Force has, in conjunction with local industry, developed a non-intrusive means of instrumenting aircraft for flight test activities.

The Non-Intrusive Flight Test Instrumentation system, or NIFTI, has been developed as a means of instrumenting an airframe for flight testing without altering its original configuration or removing it from the line for an extended period while intrusive and sometimes very complex flight test instrumentation is installed and removed.

Initial trials with the system were carried out in late 2015 with promising results, and a program of further activities will be conducted later in 2016.

Formerly known as the Aerospace Operational Support Group (AOSG) the Air Warfare Centre oversees four directorates, one of which is the Testing and Evaluation Directorate, which in turn oversees the Royal Australian Air Force's chief testing unit, the Aircraft Research and Development Unit (ARDU).

The NIFTI system is an example of the innovative approach to problem solving for which the Air Warfare Centre was formed, and embraces the principles of the RAAF's Plan Jericho, a blueprint for innovation and forward thinking designed to develop informed processes for acquiring and developing capability and to position the service for the so-called '5<sup>th</sup> generation' capabilities of the future.

## WHY NIFTI?

The capture of flight test data, from something as simple as recording accelerometer information for monitoring *g*-force loadings, to complex flutter testing of aircraft structures under different loads and in varying configurations, has traditionally involved dedicated test fleets that are extensively modified for the purpose.

For a medium-size force like the Australian Defence Force, it is becoming more difficult to dedicate an aircraft such as the Lockheed Martin Joint Strike Fighter, each of which will cost around US\$90m, purely for flight testing.

Traditional flight test instrumentation at least temporarily and often permanently requires the modification of small numbers of aircraft with customized equipment installations, which are designed specifically to collect the data required. Although this approach provides the testing organization with a responsive capability development support tool,

## “Our NIFTI system is designed to reduce or remove the bottlenecks created by conventional instrumentation”



2 // The NIFTI sensors send information using bespoke wireless technology to a unit mounted in a pod, which is typically carried on an external hardpoint

it comes at the expense of operational availability, as the aircraft is off-line as a weapons system as a consequence.

Flight test instrumentation can also be installed on an as-required basis, for a single trial or a series of trials. This approach has the advantage of maximizing operational availability, but it comes at the expense of the responsiveness often required for problem solving.

Both philosophies require the aircraft to be in maintenance for extended periods. This often has a negative impact on the capacity and willingness of operators to dedicate aircraft to a flight test program, or to contemplate undertaking projects that require complicated instrumentation fits, with consequential negative influences on operational capability.

“Our NIFTI system is designed to reduce or remove the bottlenecks created by conventional instrumentation by providing a generic system that can be rapidly installed on an aircraft, in any configuration,” explains Group Captain Tobyn Bearman of the Air Warfare Centre. “The time taken to install a conventional flight test instrumentation system is determined in part by the complexity of that system and the electrical wiring that is usually required. Typical installation times can be as short as two weeks, but they can be as long as two or three months.”

3 // The sensors can be attached to any external, and some internal, surfaces, as seen here on the fin of an RAAF Pilatus PC-9/A trainer



The conference dedicated to

# THE PATH TOWARDS ELECTRIC FLIGHT!

50+  
speakers  
Two conference  
streams!

DELEGATE  
PLACES ARE  
LIMITED  
BOOK ONLINE  
NOW!



Volt future aircraft: ©NASA/BOEING/SCIENCE PHOTO LIBRARY

## electric & hybrid aerospace

TECHNOLOGY SYMPOSIUM 2016

The conference that brings together aerospace industry R&D engineers and heads of design and engineering to discuss, debate and analyse future possibilities for the hybridisation of aircraft and even the possibility of pure electric-only commercial flight.

**9-10 NOVEMBER 2016** COLOGNE, GERMANY



From the publisher of *Aerospace Testing International* magazine

[www.electricandhybridaerospacetechnology.com](http://www.electricandhybridaerospacetechnology.com)

Over 200 delegates  
Participated last year  
Join the debate  
in 2016!



## AIR WARFARE CENTRE

On January 11 this year the Air Warfare Centre became the latest of the Royal Australian Air Force's Force Element Groups (FEGs) to achieve initial operational capability (IOC), replacing the previous Aerospace Operational Support Group (AOSG).

"Before the Air Warfare Centre, the Air Force lacked the framework to generate truly integrated capability solutions. Evolved from the Aerospace Operational Support Group, the AWC retains the foundation roles of test and evaluation, information warfare and the management of test and weapons ranges," explains Group Captain Tobyn

Bearman, the AWC's director of test and evaluation.

The AWC is expanding to include the development of live, virtual and constructive simulation expertise and the development of an integrated tactics and training capability, which are delivered across the test and evaluation, information warfare, air force ranges, and tactics and training directorates.

"The AWC is now able to deliver expert support from each directorate, but its real strength comes from its ability to simultaneously access subject matter expertise across those domains to address air power problems and provide truly integrated solutions,"

continues Bearman. "In response to a request from the field, a task is raised in our integrated mission support (IMS) system and either assigned as the sole responsibility of a single directorate if the task is discrete, or one which requires coordinated input from multiple subject matter experts.

"For the latter, an integrated project team will generally be established. The AWC is about the delivery of innovative solutions – tasks are accepted and analyzed for opportunities to innovate and complex tasks are tackled by IPTs drawn from diverse backgrounds, who come together to seek out innovative methods and solutions."

Gp Capt. Bearman is the current director of test and evaluation at the Air Warfare Centre and is an aeronautical engineer with experience in aircraft maintenance, sustainment, and flight test and engineering operations. Prior to his current role, he has held the positions of test manager for the RAAF's Airbus KC-30A Multi-Role Tanker Transport (MRTT) program, chief engineer for Air Force Test and Evaluation, and director of enabling capabilities at Air Force Headquarters in Canberra.

The NIFTI solution was jointly developed in Australia by the companies AADI Defence and Procept, together with the Defence Science and Technology Group (DST Group) and the RAAF's Aerospace Systems Engineering Squadron (ASESQN). The Defence/industry consortium formed an integrated project team (IPT), an Air Warfare Centre initiative designed to gather a small team of resources from diverse backgrounds to provide innovative solutions to complex problems.

Funding has also been provided by the US Air Force Seek Eagle project office, which sees the potential for NIFTI across the huge international Joint Strike Fighter program.

3

NIFTI testing phases

15 MINS

Time it took for the control installation of NIFTI

24

Maximum number of sensors that can be integrated into a NIFTI system

### NON-INTRUSIVE SYSTEM

The NIFTI system comprises a series of battery-powered wireless sensors that can be temporarily mounted on any external surface of the aircraft. Because they are attached by adhesive, the entire system can be installed in hours, rather than days, weeks or months.

The sensors send data to a pod, which can be mounted on any standard pylon, using a bespoke wireless technology system. The sensors use wireless mesh network topology, which means the sensors do not need to be in line of sight with the instrumentation pod, which is typically mounted on an underwing hard point.

Up to 24 sensors can be used with the system, but the initial concept

demonstration last year was carried out with a 10-sensor fit. The NIFTI system is also controlled wirelessly and can be controlled from the cockpit, by either the pilot or a dedicated flight test engineer.

The initial NIFTI prototype was developed in eight months and was installed on one of ARDU's Pilatus PC-9/A aircraft before being flown in a series of concept demonstrations beginning in September 2015.

"The prototype system included 10 sensors mounted externally, as well as in the cockpit and baggage compartment, and a wing-mounted pod for system control," explains Gp Capt. Bearman. "Once the prototyping was complete, control installation of the 10 sensors was completed in 15 minutes."

The concept testing also considered NIFTI's ability to reliably record accurate test points while being subjected to the extremes of the PC-9/A's flight envelope, including the airframe's maximum-permitted positive and negative g-force limits during aerobatic maneuvers.

"The trial successfully demonstrated how an integrated team can develop, prototype and then rapidly

4 // Maintaining dedicated fleets of permanently instrumented examples of modern aircraft is often prohibitively expensive



5 // Phase two of the NIFTI program will be an air-to-ground weapons clearance campaign on an ARDU F/A-18A/B Hornet later this year



configure an aircraft to collect flight test data,” continues Gp Capt. Bearman. “The innovation of this system spans several domains. We used commercially available glue strips to fit the sensors to the aircraft and the sensors themselves use a version of wi-fi to communicate with the pod and to collect information. We don’t have to take an aircraft off-line for long periods of time to instrument it to obtain the desired result, be that for a problem investigation, to collect data required for certification, or to confirm the airworthiness of a system.”

One of the important steps in testing of the NIFTI system before flight trials took place was a series of tests to prove that electromagnetic interference (EMI) produced during operations would not have a negative effect on either the aircraft or its systems. Initial testing was carried out in the hangar at RAAF Edinburgh in South Australia (home to the AWC and ARDU) and also in a dedicated EMI chamber, where the aircraft was subjected to repeated tests under a range of conditions.

The technology used in the development of NIFTI is Australian industry intellectual property, which was originally developed for telecommunications, mining and medical applications.

“The effort to take this technology and optimize it for flight test was accomplished by a small integrated project team consisting of Air Warfare Centre engineers; pilots; Defence Science and Technology Group scientists; and design engineers from Australian industry,” adds Gp Capt. Bearman.

### FLIGHT TEST, TRIALS AND THE FUTURE

The successful PC-9A concept demonstration marked the completion of the first phase of a three-phase capability development program aimed at producing a system that Gp Capt. Bearman says is expected to be able to be used on any aircraft type. The results of the demonstration have been combined with a series of evolved objectives to create a scope for the next phase of trials.

**“The entire system can be installed in the host aircraft in hours, rather than days, weeks or months”**

Phase two of the program will be demonstrated through an air-to-ground weapons clearance campaign on an RAAF F/A-18A/B Hornet strike fighter in October of this year.

“That system will be capable of capturing high-accuracy strain and vibration data and will include an improved ability to monitor system health and control system parameters from the cockpit,” says Gp Capt. Bearman. “In parallel with phase two, the team in the Air Warfare Centre is looking ahead to phase three and how we might apply that system to the Joint Strike Fighter environment.”

In conclusion, Gp Capt. Bearman says that, in order to meet the challenges posed by the rapidly evolving technical landscape and the constraints that come with some of the complex and evolved systems the ADF is introducing into service, the Air Warfare Centre is adopting the principles of Plan Jericho.

“Our mission is to help transform the way we develop and acquire capability. We’re doing this to help create a future combat capability that is highly adaptable and able to deliver decisive results whatever the context.” \



The conference dedicated to

# SAVING FUEL, LOWERING EMISSIONS, REDUCING NOISE

DELEGATE PLACES ARE LIMITED  
BOOK ONLINE NOW!



N3-X hybrid wing aircraft: ©NASA/SCIENCE PHOTO LIBRARY

50+ speakers  
Two conference streams!

## electric & hybrid aerospace

TECHNOLOGY SYMPOSIUM 2016

The two-day conference will cover all aspects of aerospace activity, from commercial aviation to military applications. Its purpose is to highlight the ever-growing research into the increased electrification of aircraft and the possibilities and challenges that brings.

**9-10 NOVEMBER 2016** COLOGNE, GERMANY



©Solar Impulse

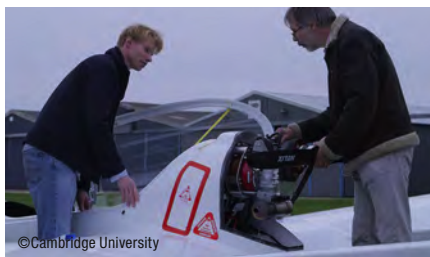

©Cambridge University



From the publisher of *Aerospace Testing International* magazine

[www.electricandhybridaerospacetechnology.com](http://www.electricandhybridaerospacetechnology.com)

Over 200 delegates participated last year  
Join the debate in 2016!



The conference dedicated to  
**SAVING FUEL, LOWERING**

**50+**  
speakers  
Two conference  
streams!

# electric & hybrid aerospace

TECHNOLOGY SYMPOSIUM 2016

# THE PATH TOWARDS

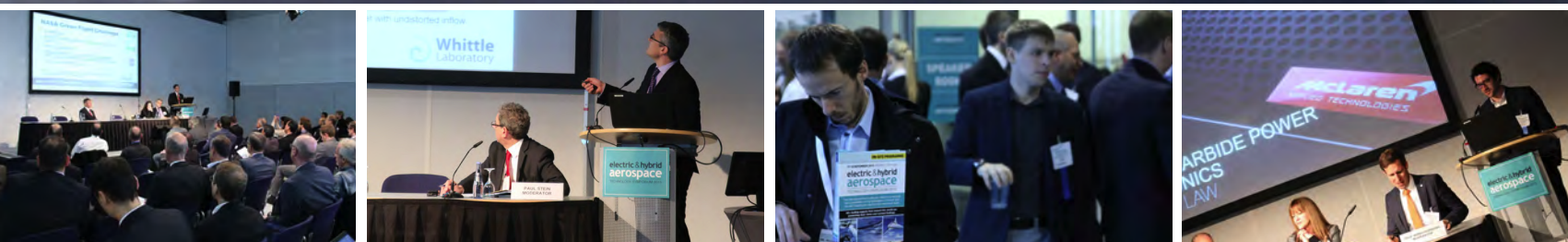

From the publisher of *Aerospace Testing International* magazine

[www.electricandhybridaerospacetechnology.com](http://www.electricandhybridaerospacetechnology.com)



# EMISSIONS, REDUCING NOISE

Introducing the international conference dedicated to the increased electrification of commercial and military aircraft. The path towards fully electric flight.

DELEGATE PLACES ARE LIMITED  
**BOOK ONLINE NOW!**

**9-10 NOVEMBER 2016** COLOGNE, GERMANY



H series future aircraft | NASA/BOEING/SCIENCE PHOTO LIBRARY

# ELECTRIC FLIGHT!



Electric & Hybrid Aerospace Technology Symposium 2016 | Contact: Andrew Boakes  
UKIP Media & Events, Abinger House, Church Street, Dorking, Surrey, RH4 1DF, UK  
Tel: +44 1306 871209 • Fax: +44 1306 742525 • Email: [andrew.boakes@ukipme.com](mailto:andrew.boakes@ukipme.com)

**Over 200 delegates participated last year**  
Join the debate in 2016!



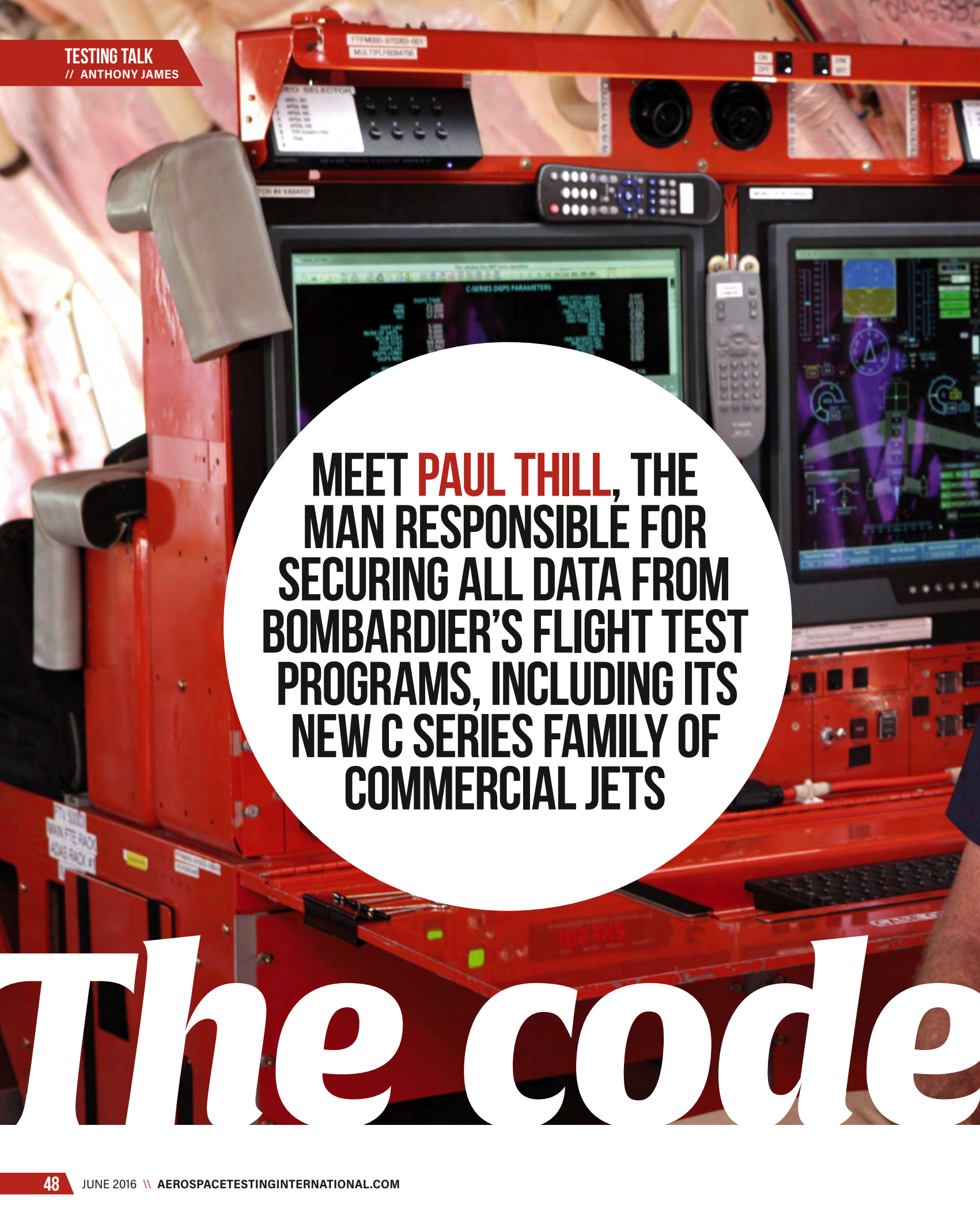

MEET **PAUL THILL**, THE  
MAN RESPONSIBLE FOR  
SECURING ALL DATA FROM  
BOMBARDIER'S FLIGHT TEST  
PROGRAMS, INCLUDING ITS  
NEW C SERIES FAMILY OF  
COMMERCIAL JETS

# The code





# breakers



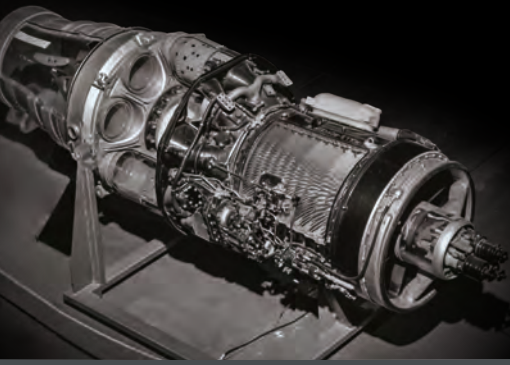

**bustec**  
WHEN ACCURACY MATTERS



# Distributed, High-Precision Data Acquisition

The ProDAQ family  
and LXI technology

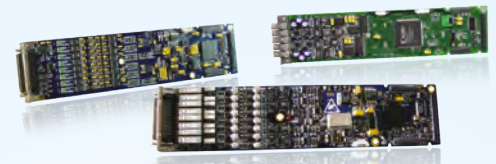

The ProDAQ family includes various function cards such as Analog to Digital Converter, Digital to Analog Converter and Digital I/O function cards.

You can fit up to 4 ProDAQ FUNCTION CARDS in a LXI CARRIER...

Mechanical Airframe Testing

Wind Tunnel Applications

Turbine and Engine Testing



...and rack up to 2 LXI CARRIERS in 1U of rackspace.

visit [www.bustec.com](http://www.bustec.com)

## Contact us

**Europe**  
Bustec Ltd.  
Shannon Business Park  
Shannon, Co. Clare  
Ireland  
tel +353 61 707 100  
fax +353 61 707 106  
sales@bustec.com

**North America**  
Bustec Inc.  
1507 East Valley Parkway  
Suite 3-412  
Escondido, CA 92027  
tel +1 (512) 850-6593  
fax +1 (270) 637-3003  
sales@bustec.com

**India**  
Bustec Ltd.  
23 Muneeswara Temple A St  
Cleveland Town  
Bangalore 560008  
tel +91 9845100173  
fax +91 8025806694  
sales@bustec-india.com

**China**  
Bin Zhou  
tel +86 139 1052 8152  
bin.zhou@bustec.com





1 // Cabin view of C Series Flight Test Vehicle 3 (FTV3), packed full of flight test equipment (All photos: Doug Dalgarno)

### // WHAT IS YOUR CURRENT POSITION AND WHAT DID YOU DO BEFORE THAT?

I'm currently the manager of aircraft instrumentation and data services at Bombardier's Flight Test Center – or BFTC as we call it – based in Wichita, Kansas. I manage a team of over 75 electrical engineers, software engineers, laboratory technicians, ground station operators and data management personnel. I've held this position since March 2012, having previously been section chief of instrumentation design at BFTC since March 1998, where I led a 40-strong team in supporting all instrumentation design activities on 10-15 flight test aircraft. Prior to that I was a senior engineer in instrumentation design, having previously spent nearly four years as a senior engineer on the C-17 flight test operations team at McDonnell Douglas Aerospace.

### // HOW DID YOU GET INTO AEROSPACE TESTING?

I'd been studying electronics engineering at the Oregon Institute of Technology for about 2.5 years, but I was struggling to connect what I was learning with the real world, so I took a break to work as an intern at McDonnell Douglas (later acquired by Boeing). I worked in the testing lab designing and building controllers for ground test rigs. We did some really fun stuff – we would take a tire and spin it up to landing speed and then slam it on to a stationary tire to simulate a landing for tire testing. We also did some work with nitrogen generation systems, which was pretty new and exciting at the time.

Back then, we had to design and build our own circuit boards. We'd lay out the circuit boards by hand on a piece of plastic using tape, take a photo and then use the negative to make the boards by exposing them to sunlight, before adding all the components, testing the boards and building the relevant controllers.

I then went back to college and finished my degree. I'm now a strong supporter of internship programs, and believe we need to get more young folk involved in test engineering. We support the national Science Technology Engineering and Math (STEM) program, which aims to inspire young people to pursue technical careers, and we take students on tours of BFTC and send our engineers out to work with them in the classrooms.

### // WHAT WAS YOUR FIRST TESTING JOB?

After I graduated I went back to Douglas, to take a job in the test lab department. One of the first things I worked on was testing the landing gear for the T-45 Goshawk, a Navy trainer aircraft. We were responsible for instrumenting strains and pressures on the main gear and we also took the whole aircraft and dropped it from 15-20ft in the air to simulate carrier landings – which was interesting! Back then, the data system was a mainframe computer – if you wanted to program it or change anything, you had to use a terminal in the test room – there was no network and there was no personal computer on my desk. One thing that really sticks in my head is, prior to testing, we had to go and zero all the string gauge channels with a screwdriver, tweaking them to zero every day. How things have changed!

***“The C Series was a quantum leap for us on the instrumentation side”***

### // ANY EARLY LESSONS LEARNED?

Early in my career I was assigned to an engine test facility out in the Arizona desert, which had been closed for about 10 years, and was in need of refurbishment. One of our first tasks was to create an interface panel on the test stand to connect our test engine instrumentation to the data acquisition system in the control room. So we ordered more than 50 solder pin connectors to get the job done. However, when they arrived it quickly dawned on us that the time required to solder them all would not support our test schedule. Speaking with the technicians, we decided that crimp connectors would be a better option and the design was changed. The lesson? Always talk to the people who are going to do the task to ensure your designs are producible and optimized to meet the schedule in the real world. Another valuable lesson came



# Multi-Channel Measurement Solutions for More Electrical Aircraft (MEA)

*High precision Data Acquisition Instruments and powerful Analysis Software for versatile measurement tasks.*

- › Variable Frequency Drive Tests
  - › Power Converter Tests
  - › High Voltage Circuit Breaker Tests
  - › Solid State Switch Tests
  - › Power Distribution Monitoring
  - › Spike Detection on Power Lines
- 
- › 4 to 1024 simultaneous Analog Input Channels
  - › Multiple Instruments in One Device  
(Transient Recorder, Power Analyser, Data Logger, Oscilloscope)
  - › Autonomous Recording
  - › Post Analysis with powerful Formula Editor

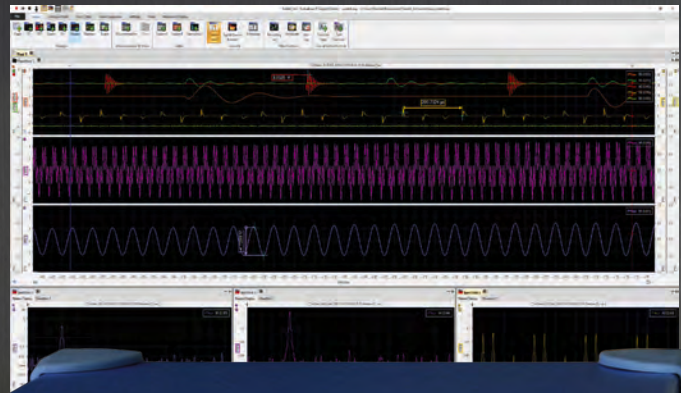

[www.elsys-instruments.com](http://www.elsys-instruments.com)

## WIRELESS DATA ACQUISITION: Reduce Flight Test Delays

Faster installation + Reduce wiring weight + Reach inaccessible locations

**CURTISS -  
WRIGHT**

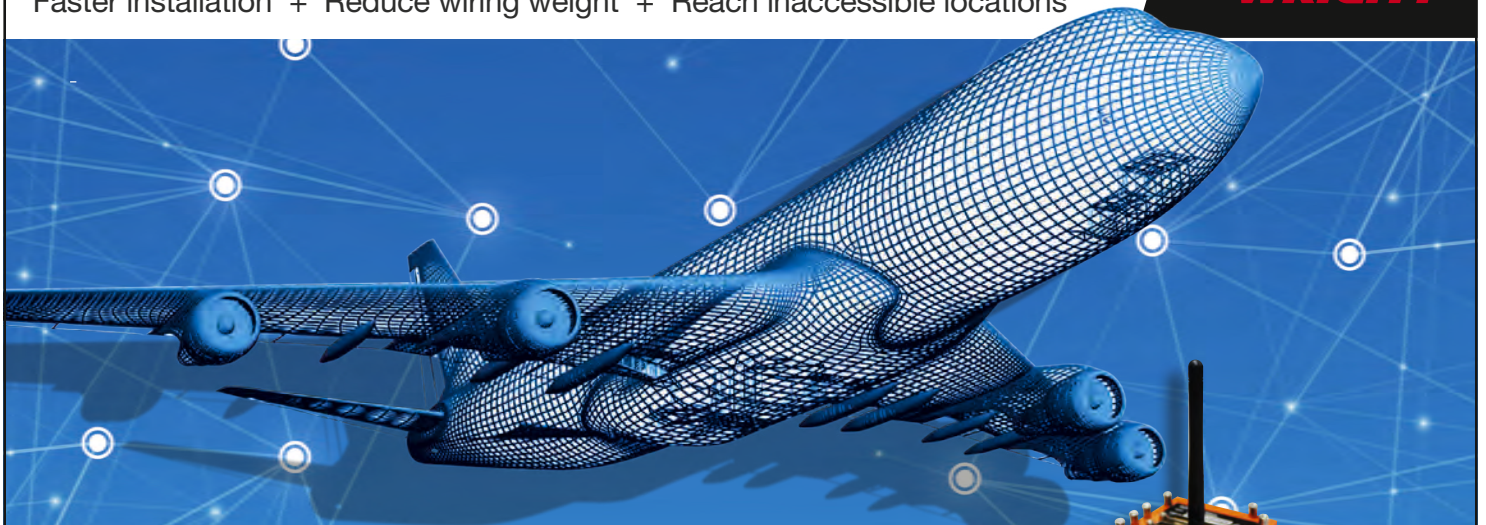

### Wireless data acquisition is now ready to deploy

- + Wide range of off-the-shelf sensors available
- + LXRS® protocol addresses contention, synchronization and RF interference concerns
- + Seamlessly integrates into wired system to support both wired and wireless sensors

[CURTISSWRIGHTDS.COM](http://CURTISSWRIGHTDS.COM)



from my time on the C-17 Globemaster test program, when I discovered you should always make your wires at least 10% longer than you think they need to be – you can always cut them shorter, but they're awfully hard to stretch!

### // TELL ME MORE ABOUT YOUR CURRENT ROLE.

I've got a team of over 70 engineers and techs and we're responsible for all the flight test systems and tools that we use to certify and test Bombardier aircraft. That covers safety systems, metrology, data acquisition, all the flight test equipment, telemetry, ground station, all the services in the ground station, our telemetry rooms, the data storage, real-time data display, distributing the data post flight, and all the software tools that are used to manage our flight test programs. I spend most of my time making sure my team has the tools and equipment they need to support all of our flight test programs.

### // DESCRIBE A TYPICAL DAY.

That's tough as flight testing is such a dynamic environment with constant challenges to address. You come into work in the morning with a plan, but by the afternoon that plan has changed drastically because you have to adapt. My day is normally spent ensuring that any major challenges are addressed and that my team has what it needs to perform its tasks. The fun part of the job is looking at and evaluating new equipment and technology to support our future programs, particularly on the data acquisition side of things. We're always looking for equipment that will stand up to the tough conditions endured

during flight test. We're also looking for recorders that can merge different data sources – three or four types of aircraft bus data, as well as video data. We really don't want to process any more media types than we have to, so that's also a key consideration. And we always want to find things that don't add much to the aircraft weight.

## “Data is becoming a lot easier to collect from the aircraft systems themselves”

### // WHAT PROGRAM ARE YOU CURRENTLY WORKING ON AND WHAT ARE SOME OF THE CHALLENGES?

We're just finishing testing on the C Series, for both the CS100 and CS300. Overall the program has been a quantum leap for us on the instrumentation side. Prior to the C Series, we typically had at most 5,000 parameters on a flight test aircraft. On the C Series that increased to about 20,000 parameters per aircraft and that doesn't even include the Arinc-664 and time transfer protocol (TTP) bus data that we bulk recorded. During the CS100 flight test program, which is the smaller of the two aircraft, we captured and provided data for about 30 million individual parameter requests across two dedicated test sites and numerous off-site locations.

The number of parameters overwhelmed our previous equipment, so we had to move to higher-capacity systems and develop new methods to process the amount of data and make it available to people in an easy way to view. As for the overall amount of data generated during testing, I can tell you we've captured about 400TB to date.

The C Series was also our first underwing engine aircraft, so we quickly discovered that we couldn't run all the wiring in from the engines into the fuselage to our data collection system. We had to move to a more distributed architecture with acquisition units on the engines and out on the wings, with communication wires running back into the cabin. So that was probably one of our biggest changes on the program.

### // IS DATA ACQUISITION GETTING ANY EASIER?

Data is becoming a lot easier to collect from the aircraft systems themselves, which transmit a lot of the information that we used to have to collect with individual sensors. On our latest programs I'd say about two-thirds of our total requests are from integrated aircraft bus parameters and those are a lot cheaper to install and we encourage people to use those

2 // Data recorder and acquisition unit installed on FTV3, which is dedicated to avionics testing

2

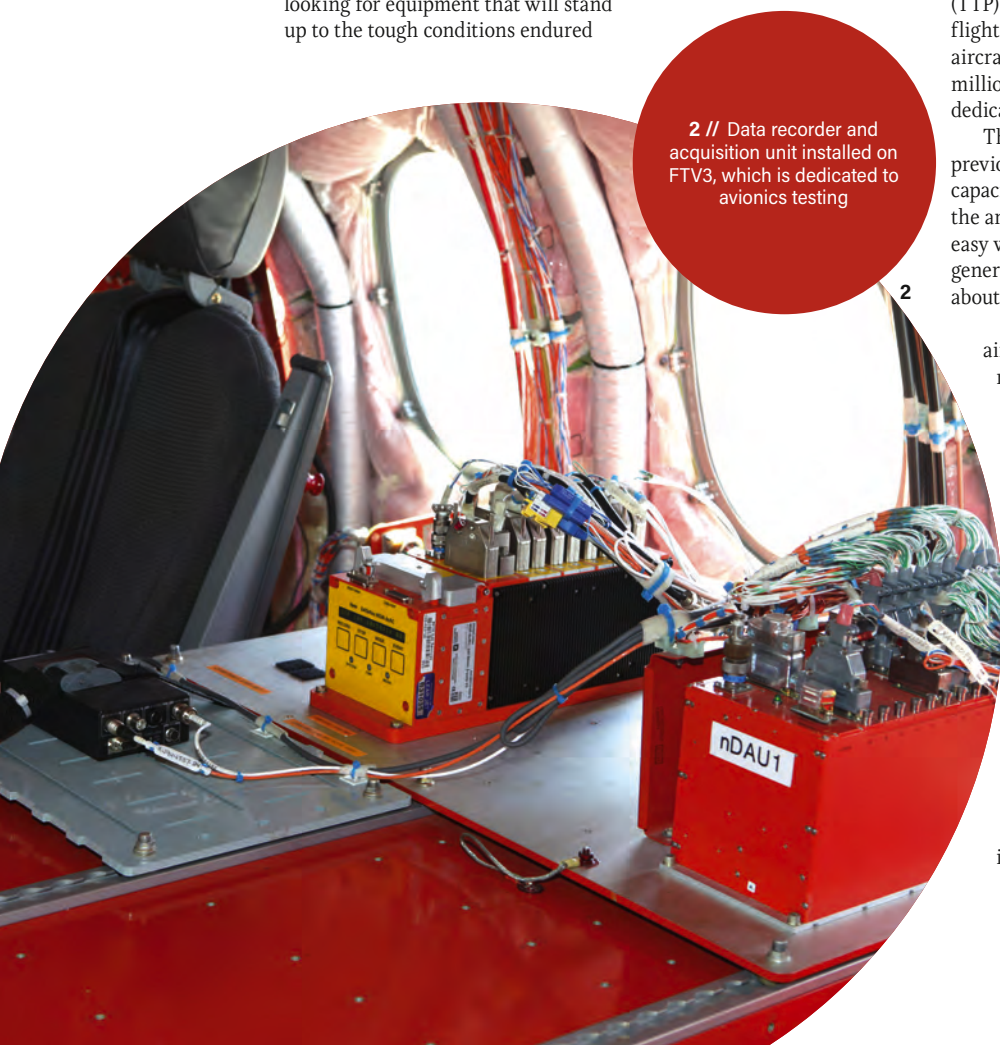

# Reliable Data Recording Solution from TEAC

# TEAC®

The WX-7000 Series, a new Portable Instrumentation Data Recorder family of products, are designed to provide multi-channel high-bandwidth data recording solutions for testing and monitoring requirements in aerospace.



- Stand-alone and Intuitive Operation
- 80kHz Wide Frequency Bandwidth
- 100dB Wide Dynamic range
- Whole Day Extended Recording Time
- Up to 128 Channels Recording



<http://datarecorder.jp/en/>

**TEAC Europe:**  
Wiesbaden, Germany  
+49 (611) 71 58 0  
ipd-sales@teac.de

**TEAC America:**  
Montebello, CA  
+1 (323) 726-0303  
datarecorder@teac.com

**Head office:**  
Tokyo, Japan  
+81 (42) 356 9154  
tic\_cs@teac.co.jp



## AVAP3000™ series III System

### Dynamic data acquisition system for harsh environments

A compact and rugged acquisition system for all your dynamics signals. Recommended for accelerometers, vibration, acoustic and strain gauge sensors. A comprehensive hardware and software solution, fully customizable.

#### Technical features

- 70kHz Bandwidth
- 16 versatile channels
- 0,1% DC/AC precision
- IEPE, Strain gauge and TEDS sensors
- Programmable sensor power supply
- PTP time synchronization
- 100 Mb/s Ethernet data transmission
- Temperature: -55°C to 100°C
- Input power POE (48VDC)
- Size: 180 x 120 x 55mm
- Weight: 1,8kg

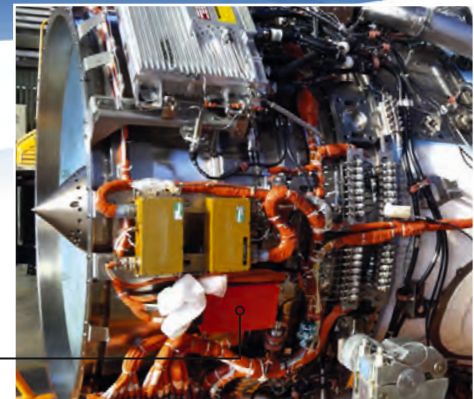

SAFRAN AIRCRAFT ENGINES  
NEW PROGRAMS

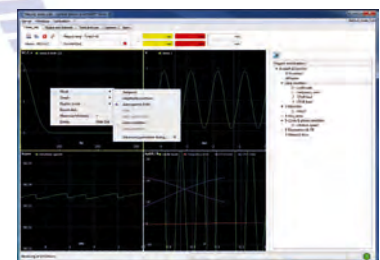

[www.adetelgroup.com](http://www.adetelgroup.com) | [sales@adetelgroup.com](mailto:sales@adetelgroup.com)

France Tel. +33 4 78 18 08 40 | Canada Tel. +1 514 312 9012





3 // Data conversion now takes place on the ground, rather than in the air, due to the sheer number of parameters being monitored

whenever possible as we're always looking at ways to reduce the cost and to utilize what's already installed on the aircraft.

When I started my flight test career back in the 1990s, if we wanted to make a change or configure data acquisition equipment we had to program an EPROM and then transfer the data onto the aircraft acquisition system. However, with current technology, our engineers program the acquisition systems in their offices and transfer the software to the aircraft with a USB drive for loading with onboard computers. Looking forward, we're investigating the potential for this to actually be performed completely from their offices.

Moving to a network-based data acquisition system on the C Series has given us a lot of capacity and we're able to acquire the much larger amount of data required to certify the latest aircraft. The ease of maintaining these systems and the throughput rates have really got better. Meanwhile the size of the acquisition equipment itself has reduced dramatically, enabling us to put equipment in the wings and other previously hard-to-access areas, which has increased our capabilities.

Data formatting remains a key issue, but the introduction of the IRIG 106 Chapter 10 telemetry standard means we can be more confident that if we use different recorders, we know we'll still get the same output files, which has enabled us to standardize some of our processing methods.

### // HOW DO YOU STORE THE DATA THAT YOU ACQUIRE AND HOW DO YOU PREVENT DATA LOSS?

All analog and bus data is recorded on the onboard data acquisition system, and it's also recorded by our display system, so we have two different recording media. We have occasionally lost data on one of these at different

points on various programs, but we've always been able to go to the alternative recording source to recover the data. Once off the aircraft, the data is stored on a RAID device, which is backed up each night to an off-site location. Archive data is put on a backup tape and stored at a local salt mine. We do a lot to make sure we don't lose our data—it's rather expensive to acquire, after all.

### // WHAT TOOLS DO YOU USE TO MAKE SENSE OF THE INCREASING AMOUNTS OF DATA?

On past programs, we converted all of our parameters into engineering units in real time on the aircraft, so we could have the data available immediately after test. The volume of parameters on our new programs means we just can't do that anymore – it has overwhelmed our onboard processing capability. We've had to go back to just recording the raw data on the aircraft and then processing it into engineering units after testing in the ground station. Luckily, today's computers are a lot faster, so we've been able to move the processing from the aircraft to the ground, but still meet our goal of having the data available within one hour of test completion.

We've also developed a tool that provides 10-second average data for each parameter for the entire test. This enables users to find the events that they're interested in and then submit data requests for those specific test points.

**“The size of the acquisition equipment itself has reduced dramatically”**

And then there's our new test data query language (TDQL) tool, which is pretty exciting, as it lets our engineering team mine existing data for specific test points and conditions. The TDQL tool will help find data that's already out there instead of having to fly a brand new test. It's a powerful tool and we hope it will help reduce test hours and make us more efficient.

Finally, we're developing some tools that will automatically monitor parameter health – it used to be that a technician could go on the aircraft and look at all the parameters in real time, but when you have 20,000 or more, you just can't do that. We want to confirm everything is working okay before we fly a flight test for nothing.

**// WHAT HAS BEEN THE BIGGEST ADVANCE IN DATA ACQUISITION?**

The big advance came with digital video recording. It's made a huge impact on our test operations. We're able to provide video data almost immediately after each test flight – it wasn't too long ago that we were still using VCRs, which would take days to provide the same data. The video data helps us trouble-shoot aircraft issues and confirm successful completion of our test flights a lot faster. We are able to share information on the day of the test and work on issues overnight and address them before the next flight.

Going forward, if I could find a recorder capable of merging different types of data, that would be very interesting to us because the less media we have to take off the aircraft and process, the more efficient and effective we will be.

***“We're looking for ways to leverage off existing flight test data”***

**// HOW HAS BOMBARDIER REDUCED THE LENGTH OF ITS FLIGHT TESTING PROGRAMS?**

We use a lot of test rigs – ‘iron birds’ that simulate all the aircraft systems, and we're always striving to identify and resolve any issues that we find well before the aircraft undergo flight testing. We also test any new flight test systems on an existing platform to make sure that we understand it, so we can develop any processes that may be needed. And as I said before, using our new TDQL tool, we're looking for ways to leverage off existing flight test data to find data that we could use instead of conducting a test flight to acquire something we already have.

**// HOW IMPORTANT IS TELEMETRY TO YOUR ROLE?**

As we normally fly with two pilots and just one or two FTEs, we depend a lot on telemetry for real-time monitoring. Some manufacturers fly more engineers on the aircraft, but we choose not to do that for safety reasons. Recently we've been testing a new capability, where we share our telemetry data between our test sites. We're able to run a test in Wichita and transmit that data in real time to Mirabel, where engineers can monitor and assess the data and communicate back with the Wichita test site. Moving forward, we're going to expand that to our Toronto site and to our mobile units. It's a constant challenge to keep the telemetry frequencies that we need to do our job as there's a lot of pressure from telecoms companies to take that bandwidth, but we need to keep enough to do what we need to do.

**// HOW DO YOU SEE YOUR ROLE CHANGING 20 YEARS FROM NOW?**

Well 20 years from now I hope to be retired! But I expect we'll be taking even more data from the production aircraft's pre-installed sensors and systems. We're going to continue to leverage off that data and try to minimize the amount of instrumentation that needs to be installed on 'test' aircraft. By far the most expensive instrumentation we install is the individual sensors to capture test data from an aircraft. It's probably 5 or 10 times more costly to put a sensor on a test aircraft than it is to just tap off an existing bus and pull the data off. So I'm pretty sure we'll be looking to leverage off the production sensors a lot more, going forward. In the past, you haven't needed as much accuracy on the production side as required on the test side, and testing also requires higher update rates than are currently available on some aircraft systems, but we are working with the design engineers to improve those so we can utilize flap position data, for example. If we can make some small changes to update rates and use the aircraft's existing systems instead of putting our own sensors in, it's a huge cost saving for us. \\\

4 // C Series FTV1 in flight







# DONGLING TECHNOLOGIES

600 KN Force Rated Electrodynamic Shaker



3 Axis Electrodynamic  
Vibration System



Pneumatic & Hydraulic  
Vertical Shock



Electrodynamic Shaker With  
Altitude Chamber



[www.donglingtech.com/en](http://www.donglingtech.com/en)  
[www.donglingusa.com](http://www.donglingusa.com)

Dongling Technologies USA  
7355 Clyde Park Ave. SW Suite 8H  
Byron Center, MI USA 49315  
+1 (616)583-8246  
Email: [equipmentsales@donglingusa.com](mailto:equipmentsales@donglingusa.com)

Dongling Technologies  
No.2 Longshan Road, Science & Technology Town,  
New & Hi-Tech Industrial Dev. Zone  
Suzhou, Jiangsu Province, 215163 P.R.C  
Tel: +86-512-6665-2225  
Email: [info@donglingtech.com](mailto:info@donglingtech.com)

Dongling Technologies Europe  
Add: Via Edison 22/24, Strada Provinciale  
30, Gudo Visconti, MI 20088, Italy  
Tel: +39 02 9440252  
Email: [europe@donglingtech.com](mailto:europe@donglingtech.com)



A new Searchmaster airborne surveillance radar is currently being tested as a key component in extending the operational life of the French Navy's Dassault Aviation Atlantique 2 (ATL2) maritime patrol aircraft

# Master





On January 29 this year Thales conducted the first flight of its new Searchmaster radar, under development as part of the wide-ranging upgrade program for the French Navy's Dassault Aviation Atlantique 2 (ATL2) maritime patrol aircraft. It was just two years after contract award and, according to Thales, demonstrated "the advanced state of development and maturity of the radar".

The Searchmaster is an airborne surveillance radar that employs an active electronically scanned array (AESA) antenna, and is derived from qualified technologies developed for the RBE2 radar of the Dassault Rafale combat aircraft.

#### MISSION ENHANCEMENT

While the ATL2's legacy Thales Iguane radar was tailored specifically for maritime patrol missions, the Searchmaster has multirole capabilities and is therefore able to detect both naval and land targets. Once fully integrated with the ATL2, it will be capable of fulfilling anti-surface warfare, anti-submarine warfare, maritime surveillance, ground surveillance and mapping, and air surveillance missions. The land mission in particular has taken on a new importance for the ATL2, which has successfully conducted overland intelligence, surveillance and reconnaissance (ISR) operations over Mali in 2013, and over Iraq since 2014.

According to Thales, the Searchmaster offers a range of 200 nautical miles against air and sea targets. Small stationary and moving maritime targets can be detected in all weather conditions and in high seas.

*Aerospace Testing International* spoke with Anne-Sophie Malot, a Thales representative, about the status of the flight test campaign, which is due to last six months.



Photo: Henri-Pierre Grolleau



## RADAR TESTING

1 // Thales Searchmaster AESA radar currently being tested by the DGA Essais en vol for fitting to the Dassault Atlantic 2 (ATL2) maritime patrol aircraft

### GROUND TESTING

Prior to the first test flight of the radar, Thales made use of ground testing to prove the basic performance of the Searchmaster. "All necessary tests to validate the sensor technical capabilities and performance were performed in simulated environmental conditions," says Malot, "as well as all the tests necessary to qualify the sensor as flyable. The main tool used on the ground was the anechoic chamber to test and calibrate the AESA antenna."

The flight test effort is being undertaken by an integrated team that includes personnel from Thales, the French General Directorate for Armament (DGA), the French military flight test center, and the French Navy's operational flight test and evaluation center (CEPA). During the campaign, the radar is being tested in real-life operating environments that include air-to-surface, air-to-ground and air-to-air operations.

"On board the ATL2 we mainly use high-density recording to be able to analyze an enormous volume of flight-recorded data on the ground," Malot explains.

As well as 'live' radar target environments (ships, aircraft, ground targets), the radar is also tested using simulated targets. The flight test campaign is taking place at Istres and Cazaux, making use of dedicated flight test locations provided by the DGA Essais en vol. As of late April, the integrated team had already performed around 100 test flight hours and was in the middle of the flight test campaign.

"In this campaign, Dassault was in charge of developing the aircraft modification in preparation for the campaign," Malot explains. "The DGA Essais en vol is responsible for the overall flight campaign and is in charge of operating the aircraft, designating the desired flight-testing scenarios from Thales specifications, and providing the required assets. CEPA is participating in aircraft operations and witnessing the development of the capability on behalf of the future Navy end-users. Finally, Dassault Aviation will be in charge of radar integration and testing of the whole combat system."

### MULTI-CAPABLE ROLES

Radar testing is reflecting the fact that the Searchmaster is intended to achieve very high-resolution radar images in a range of operating environments. "The intention is to cover all the environment and target types the radar is designed to cope with," Malot confirms. "This includes air-to-surface, air-to-ground and air-to-air, including various sea states and sea behaviors." The latter point is important considering the different radar returns found,



2 // Searchmaster will help extend ATL2's capabilities beyond maritime search and anti-submarine warfare to better serve land missions

**28**

Total number of ATL2 aircraft completed. Of these, 15 will be upgraded with Searchmaster

**75KG**

Approximate weight of the Searchmaster radar

**1,000**

Targets that can be simultaneously tracked by the Searchmaster (reportedly reduced to 100 against land targets)

**2,000HRS**

Mean time between failures (MTBF) for Searchmaster radar

for example, in the Mediterranean and the Atlantic seas, where the ATL2 routinely operates.

As well as live flight testing, the radar trials are also making use of computer simulations. "We make extensive use of computer simulations to support the radar development and testing," Malot says. "While the flight test campaign is being performed in a relatively short period [a few months], computer simulations are used throughout the development of the radar before and after flight tests. Some may combine simulated environments with replays of flight test records."

### PRODUCTION DELIVERY

The first fully upgraded ATL2 should be re-delivered to the French Navy in 2019. The Searchmaster is also available for export and integration with fixed-wing, rotary-wing and unmanned platforms. The company confirmed a first foreign order for the Searchmaster with delivery of the first production radar early 2017. The Qatar Armed Forces also signed a memorandum of understanding (MoU) for the selection of the radar to equip its optionally piloted vehicles - aircraft (OPV-A).

While the Searchmaster is at the core of the upgrade program for the ATL2, it is one facet of a €400m (US\$450m) effort that is being conducted by Dassault and Thales with the aim of keeping a 15-strong fleet of patrol aircraft in service. Further planned mission system upgrades include a digital sonobuoy acoustic processing system, the LOTI (Logiciel Opérationnel de Traitement de l'Information) mission software for

subsystems integration, enhanced operator workstations, and a new L-3 Wescam MX-20 electro-optic/infrared (EO/IR) sensor. Other upgrade work will include structural refurbishment to extend service life out to planned retirement around 2033. \\\



# VIRTUAL ENGINEERING CLASSROOM. **PURDUE DEGREE.**

When we say that big ideas are at the core of higher education — we mean it. Purdue has long been recognized as a global leader in STEM discovery and innovation — it's why we're a top-ranked online graduate engineering program, according to U.S. News & World Report. And our program offers one of the largest selections of online graduate engineering courses available.

**GRADUATE ENGINEERING. ONLINE. ON YOUR SCHEDULE.**

[www.PurdueOnlineEngineering.com](http://www.PurdueOnlineEngineering.com)

**PURDUE**  
ENGINEERING



# Time for change

Increased use of composites and hybrid structures has raised concerns with regulators about the adequacy of 'metal-centric' standards for fatigue testing



1 // Boeing 787 test airframe ZY998 undergoing fatigue testing in a special rig located in the northwest corner of Boeing's Everett facility in Washington (Photo: Boeing)

# more?



# W

ith composite materials featuring increasingly in primary structures,

aircraft manufacturers view possible enhanced test requirements differently: Airbus recognizes the value of updated rules, Boeing appears happy with the status quo. Meanwhile, airworthiness authorities await study-group recommendations about revising damage-tolerance and fatigue-testing regulations for metallic, composites, and hybrid structures.

Airbus composites stress-analysis senior expert Jean-Luc Leon-Dufour is looking for change: "We need to work on common requirements for composites and metallic structures." However at Boeing Commercial Airplanes, chief structures engineer (program technical support) David Pollard sees no need for change. "Current requirements and related guidance are comprehensive relative to composites structures," he says. "No fundamental changes are envisioned as necessary." Nevertheless he concedes the likelihood of minor change, "for example, to more general terminology where some requirements are 'metal-centric'."

Canada's Bombardier Commercial Aircraft foresees both change and rationalization. C Series aircraft program vice-president Rob Dewar expects that testing requirements will follow future technology advances and industry learning: "A better understanding at lower-level testing [coupons/elements/subcomponents/components] may permit a reduction in the quantity of required test specimens."

Following public consultation about regulations covering the composites used in public transport aircraft, the FAA last year asked the Aviation Rulemaking Advisory

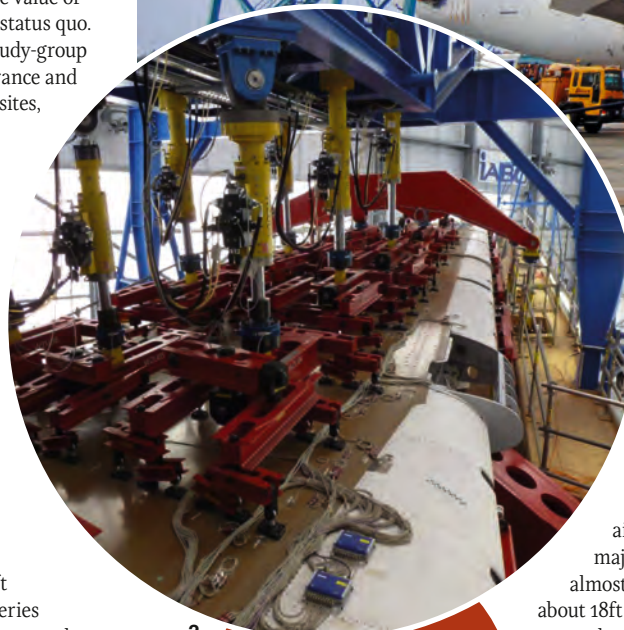

2

2 // Wingbox whiffle trees distribute the forces from the hydraulic actuators to the individual load introduction points on A350 fatigue-test subject EF2 (Photo: IABG)

Committee (ARAC), a standing industry group, to make recommendations on damage tolerance and fatigue requirements and related advisory material primarily associated with metal structures.

## FATIGUE DAMAGE REQUIREMENTS

Maintenance requirements on metallic structures underwent major change from the late 1980s as the industry addressed airworthiness assurance in the aftermath of major damage sustained by a Boeing 737 that lost almost all the fuselage structure above floor level over about 18ft of cabin while cruising at 24,000ft. New rules covered structural inspection, mandatory modification, repair assessment, and corrosion prevention and control.

Later, requirements on widespread fatigue damage (WFD) emerged and the FAA has been thinking increasingly about developments with non-metallics. Composites and metal structures are currently subject to the same fatigue- and static-test load requirements.

Officials say increased use of composites and hybrid structures has stimulated concern about adequacy of 'metal-centric' standards that do not address other materials. Composites have been in use for almost 50 years (the first all-composites civil aircraft was certificated in 1969), but now much more primary structure is made from such materials, for which full-scale testing poses technical and economic challenges.

Accordingly, the FAA tasked ARAC with evaluating requirements, setting inspection thresholds and 'limits of validity' for data supporting maintenance programs, and developing damage-tolerance data for fatigue-critical repairs and alterations. The committee should also define short- and long-term objectives, advise where guidance is needed (for example, on full-scale fatigue testing of hybrid structures), and recommend necessary rules (on, say, accommodation of thermal stresses).

## WHAT IS FATIGUE TESTING?

Fatigue testing examines aircraft structural response to stress over time and during different operations. A combination of loads is placed on the test airframe and activated by computer-operated hydraulic jacks to simulate taxiing to the runway and take-off, then climbing and cruising, before descending and landing.

For example, A380 fatigue testing lasted 26 months and represented 47,500 flight cycles, 2.5 times the number of flights an A380 would make in 25 years of operation. A 16-hour flight was simulated in just 11 minutes, the tests pushing the airframe to its limits to identify the need for any necessary design improvements.





**3 //** The 787 test airframe endured simulated loads of more than 160,000 cycles, far beyond the 787's design life of 44,000 flight cycles (Photo: Boeing)

3

Regulators also said that ARAC should consider addressing potential fatigue, environmental exposure, and accidental-damage threats, and continued operational safety of aging composites and hybrid structures. The FAA said it also should examine hybrid structure tests, including thermal effects, test duration, load- and life-enhancement factors, crack-growth retardation, bonding (or bolting) of repairs to metallic, composites and hybrid structures, and finally, certification of large modifications comprising composites or hybrid structures.

The FAA defines WFD as the “simultaneous presence of fatigue cracks at multiple structural locations that are of sufficient size and density that the structure will no longer meet residual-strength requirements”. For example, on the Boeing 757, certificated in 1982, WFD meant “at least 99% of structural details remain free of visually detectable fatigue cracking”, according to Boeing.

### TESTING STRATEGIES

For composites fatigue, Boeing shows the structure is “not susceptible to detrimental damage growth under cyclic loading”, says Polland. Meanwhile, full-scale airframe (or component) static tests are required to validate understanding of internal load distributions and failure modes and to demonstrate proof of structure.

Airbus structural-test strategy is based on a size pyramid, from coupon (or component) level up to full-scale aircraft, and can include earlier experience, according to Leon-Dufour. “Certification is achieved through analysis, supported by tests based on design principles and load-level similarities with previous programs.”

### 3 SECONDS

Length of time that aircraft test specimens must support ultimate loads without failure

### 450 METRIC TONS

Weight of steel used in the Boeing 787 fatigue-test rig

### 3,000

Sensors used to record Boeing 787 test loads



## YOUR TEST & EVALUATION DEPARTMENT

Accredited laboratory (ISO 17025, EN 9100, EN 9001, ISO 14001, EN 9712) with more than 40 years of experience in testing. Modern facilities with the latest technologies for instrumentation, control and measurement.

- ✓ Full scale structural testing
- ✓ Multiaxis complex testing
- ✓ Functional and durability testing
- ✓ Coupons & components testing



[cetestgroup.com/aero](http://cetestgroup.com/aero)

Lazkaibar s/n  
20200 Beasain · SPAIN

T +34 943 028 690  
[cetest@cetestgroup.com](mailto:cetest@cetestgroup.com)



Expert support for all types of FMEA and FMECA™

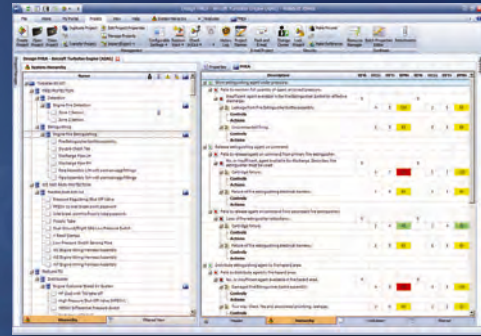
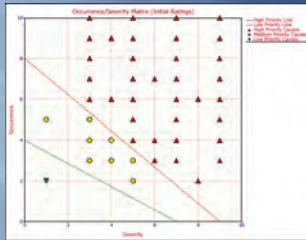

Record and manage data for new and existing failure mode and effects analyses (FMEAs) from anywhere within your organization

Assess potential failures and prioritize issues based on risk (RPN or Criticality Analysis) to initiate improvements early when they have the greatest impact for the lowest cost

Generate reports, queries and charts and integrate your FMEAs with related analyses

Employ built-in profiles for major industry standards (such as AIAG, SAE J1739 and MIL-STD-1629A)

To learn more visit: [Xfmea.ReliaSoft.com/Aerospace](http://Xfmea.ReliaSoft.com/Aerospace)

**ReliaSoft®**



Environmental Testing System  
SOLUTIONS provider

Web: [www.etsolution.com](http://www.etsolution.com)  
Email: [sales@etsolution.com.cn](mailto:sales@etsolution.com.cn)





4 // During the campaign for the A350 EF2 test specimen, the aircraft's structure was stressed with 88 servohydraulic jacks to simulate all substantial stress factors likely to occur during flight operation (Photo: IABG)

Since Airbus could not “test all possible configurations of loads and structure, we need to have extensive analysis – validated by test on critical cases at the relevant [test pyramid] level”, says Leon-Dufour. For the new A350-900, Airbus performed full-scale tests “due to the novelty of the carbon-fiber-reinforced plastics (CFRP) fuselage and wing”. For the larger -1000 under development, limited lower-level tests have been based on -900 experience.

Required primary structure tests cover areas such as static and residual strength, durability (fatigue), damage tolerance and discrete-source damage (‘ramp rash’), according to Dewar. Manufacturers are required to demonstrate that the aircraft can sustain limit loads – the maximum expected in service – “without detrimental permanent deformation” and can support ultimate loads (limit load x 150%) “without failure, for at least three seconds”, says Leon-Dufour.

Test-article numbers for an airliner such as the Boeing 787 can be “quite large”, driven by manufacturers’ experience and how many new materials are used, says Polland. “There is usually one [full-scale] airframe dedicated to static testing and one for durability [fatigue] testing – as single units, or divided into separate components. Increased composites use hasn’t fundamentally changed this.”

Bombardier’s Dewar says that hundreds of large and small articles and assemblies are produced. He believes that, in addition to full-scale static, durability, and damage-tolerance tests, a third check is needed to detect composites fatigue that could arise from the application of thermal-induced loading. “Increased use of composites means that more testing at all levels is required,” he says.

In addition to static testing, Airbus divided A350 fatigue work among nose, wing and center body, and

## BOEING 787 FIVE-YEAR FATIGUE TESTS

Nine months ago, Boeing completed five-year fatigue tests of the 787 to establish the basic strength of (and confirm inspection schedules for) the mainly composites primary structure. The work was performed in a steel rig weighing over 450 metric tons at its Everett, Washington factory. The engine-less aircraft structure was fitted with 3,000 sensors to record more than 40 million discrete compression, tension, and torsion loads applied mechanically at more than 100 points on the 787’s fuselage, tailfin, and wing leading edge. Loads simulated those experienced by a 787 in over 160,000 flight cycles (FC), each involving taxi, take-off, climb, cruise, descent, landing, and taxi elements. The tests represented almost

365% of the aircraft’s 44,000-FC design ‘life’ and a third more than were used in testing the preceding 777 design.

Fatigue testing had been delayed nearly two years while Boeing reinforced the center wingbox/wing attachment area and modified the test airframe. Lower-density composites helped keep weight down, while also enhancing fatigue and corrosion resistance. The improved fatigue life means reduced maintenance with increased inspection intervals that see a first external visual check after six years and the initial heavy-maintenance shop visit at 12 years. The composite structure’s increased fatigue resistance should see 60% fewer maintenance man-hours compared with the 767.

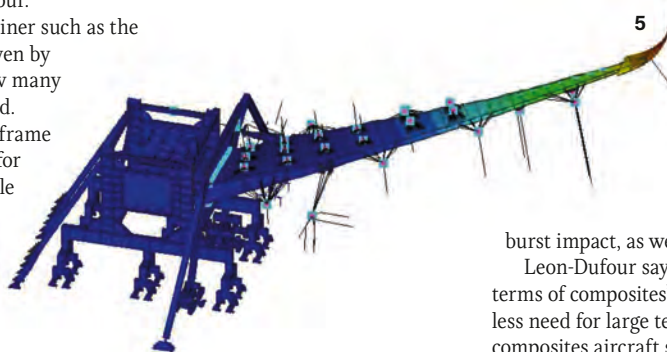

5 // Airbus and IABG have proposed the combined static and fatigue testing of composite aircraft structures within one test setup using a multibody simulation model (Photo: IABG)

5

rear-fuselage specimens. CFRP fuselage-barrel and wing specimens were subject to composites stress methods that addressed damage tolerance, ultimate load, margin research, and tire-burst impact, as well as manufacturing capability.

Leon-Dufour says, “Our knowledge is increasing in terms of composites’ good fatigue behavior, resulting in less need for large tests.” Airbus has been using large composites aircraft structures, such as tailfins, since the 1980s. Rules regarding metallic structures accommodate WFD to ensure the safety of mature aircraft, and regulations introduced 20 years ago require full-scale fatigue tests “up to two lifetimes”.

### FATIGUE AND STATIC TESTING DIFFERENCES

Regarding differences between fatigue and static testing of composites and metallics, these are more important in the fatigue regime, according to Polland. “Tests of

6 // Different positions for hydraulic actuators (specimen in jig-shape) from Airbus and IABG's combined static and fatigue test proposal (Photo: IABG)

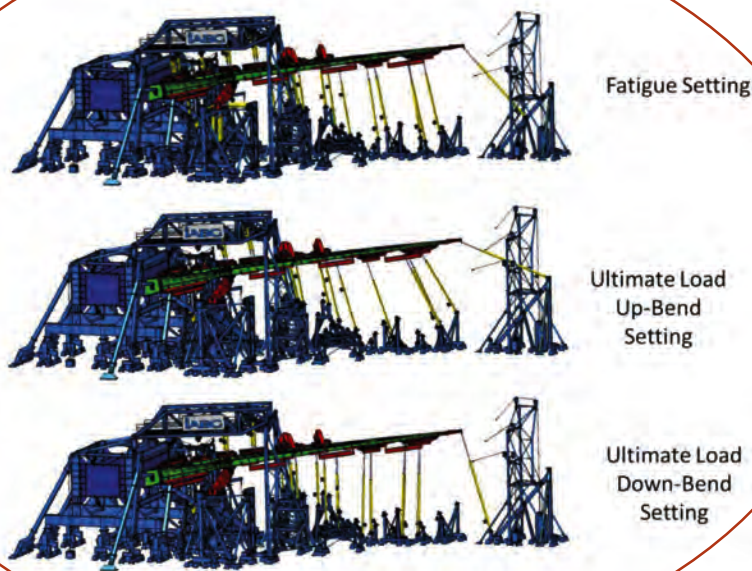

composites typically include accidental damage [introduced to mimic what could occur in service]. There is very little difference in static testing, other than the inclusion of environmental effects and accidental damage for composites. Metallic structures are insensitive to environmental conditions in service [other than corrosion].”

Leon-Dufour outlines three differences among materials during tests. First, metallics are mainly affected by low-level loads with high-number cycles, while composites respond to high-level loading with limited cycling. “Metal structures are sensitive to, say, an 0.5 limit load (LL) during 100,000 flight cycles (FC) and composites to 1,000 FC at 0.9 LL. Crack propagation is slower in cases of high load, due to the plasticity effect,” says Leon-Dufour. Composites airworthiness regulations do not allow any cracks – the so-called ‘no-growth’ approach – which he says has led to limiting of composites strain levels.

Second, there is the safety margin. For metallics this is “usually handled by a life-enhancement factor [a minimum of twice the design service goal] and for composites a load-enhancement factor [for example, 1.17 x the fatigue load]”, says Leon-Dufour. “To ensure safety you could enhance the test duration [life-enhancement factor] or the load level [load-enhancement factor].”

**4,000**  
‘Flights’ per week performed on the Airbus A350 wing fatigue-test rig

**40 MILLION+**  
Discrete compression, tension, and torsion loads applied on Boeing 787 test structures

Third, composites structure cells are fatigue tested (including up to ultimate load) during aircraft certification with one common cell. Equivalent metallic testing usually uses two different cells, with only one year of in-service representative fatigue loading required before airworthiness approval.

Bombardier’s Dewar adds that the fatigue spectrum is “different for composites with a lower scatter factor – 1.5 versus 3 – and uses more damaging occurrences than the metallic spectrum. Consequently, the number of cycles to be tested on large composites is lower than on metallic components”.

Current aerospace composites materials do not demonstrate sensitivity to fatigue-damage accumulation at the loads usually experienced by commercial aircraft, according to Polland: “In future, durability testing will continue to focus on metallic structures and their sensitivity to fatigue damage. Full-scale fatigue tests also substantiate limits of validity (LOV) supported with additional test data, structural analyses, and service data.”

Leon-Dufour says that composites parts do not require an LOV. The three A350 fatigue test cells are used to support LOV determination for metallic parts.

Finally, full-scale fatigue-test articles are usually taken apart in a thorough teardown inspection, according to Dewar: “A fatigue/damage-tolerance specimen will be nearly completely dismantled to inspect all parts for hidden cracks.” Polland concurs: “Detailed destructive investigation is necessary to fully characterize the end-state of the test article.” \

## AIRBUS A350 WING TESTING

Full-scale static, fatigue, damage-tolerance, and functional tests of the Airbus A350’s wing were performed on a single setup. German specialist IABG provided the test rig, mechanical and hydraulic components, and control, monitoring, and data-acquisition equipment for the work, which focused on certification of the CFRP behavior in conjunction with metallic materials.

The main test, including integral high-lift systems functioning, was to prove static and fatigue behavior of the CFRP, which comprised over 50% of the primary structure. The fatigue element required high test speeds to perform about 4,000 ‘flights’ per week with about 40 load cases per flight and deflections up to limit load (the highest likely in normal operation).

The many fatigue-loading conditions and corresponding deflections between limit-

load up-bend and down-bend and different torque conditions required hydraulic-actuator movement through a wide range, according to Airbus and IABG engineers. The static-test campaign included wing up-bending to ultimate load – 50% above limit load.

Functional testing checked high-lift system movement under 1g deflection and a torque test of related driveshafts under limit-load up-bend, using 18 actuators applying loads through 244 fittings above the wing’s inboard half and below its outer half. Some 3,000 strain- and deflection-data channels were recorded, the high 100Hz sample rate being necessary to ensure a detailed record in the event of specimen failure during static tests to ultimate load, or in emergency shutdown during static or fatigue testing.



# Get Your Hands on DIT-MCO's New Portable Cable Tester



Model HT-128 Handheld Cable Tester

- Battery powered, wireless communication for remote testing
- Troubleshoot installed cables
- Ideal for MRO or bench testing
- Tests for opens, shorts and mis-wires
- 128 test points, use up to 8 units for multiple branch harnesses



**Put us to the test today.**

Call 800-821-3487 or visit [www.ditmco.com](http://www.ditmco.com) for more information.

© 2016 DIT-MCO® International LLC. All brands and products are registered trademarks or trademarks of their respective holders. All rights reserved. EOE.



Leading competence in servohydraulic test systems

Hydraulic cylinder with hydrostatic bearing, peak load between 2 kN and 4,000 kN, higher loads on request

Rotary drive for torques of 500 Nm to 32,000 Nm with hydrostatic bearing, or up to 100,000 Nm as a custom solution

Supply and connection unit, adjustable pressure and flow, all safety valves are redundant, immediate cut-out in case of emergencies

Hydraulic power supply with separate filter and cooling circuit resulting in a great durability of the servo valves

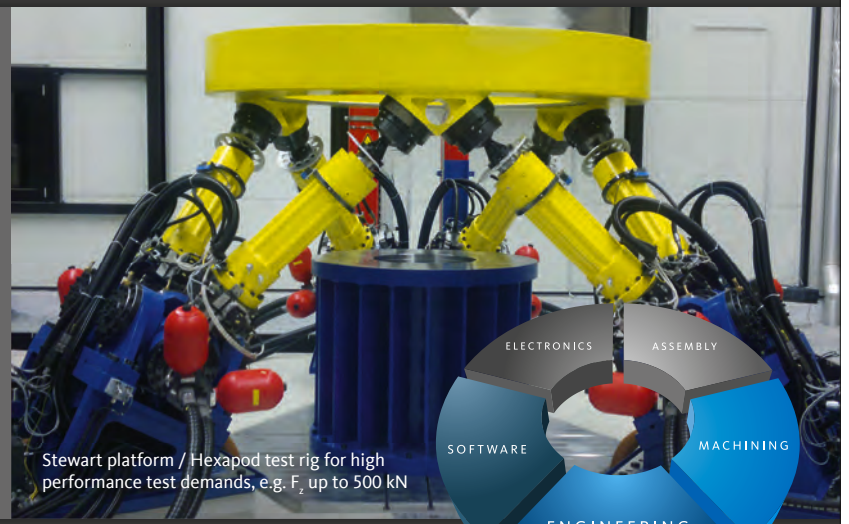

Stewart platform / Hexapod test rig for high performance test demands, e.g. F, up to 500 kN

Request product information and company profile: [www.fgb-steinbach.de/testsystems](http://www.fgb-steinbach.de/testsystems)

Fertigungsgerätebau Adolf Steinbach GmbH & Co. KG | Strahlunger Straße 18 | 97616 Salz | Germany  
Tel.: +49 (0) 9771 68877-500 | Fax: +49 (0) 9771 68877-502 | E-Mail: [info@fgb-steinbach.de](mailto:info@fgb-steinbach.de) | [www.fgb-steinbach.de](http://www.fgb-steinbach.de)

STANDARD COMPONENTS AND CUSTOM SOLUTIONS  
FULL-SERVICE PROVIDER FOR DIVERSE INDUSTRIES  
CLOSE COLLABORATION WITH UNIVERSITIES  
QUALITY THROUGH IN-HOUSE MANUFACTURE

# Heavy





# hitter

CH-53K development testing puts active-duty US Marines into the King Stallion early in the process, to refine the replacement heavy lift helicopter and improve test efficiencies



1 // The CH-53K ground test vehicle provides a means to test drivetrain and systems components on an accelerated schedule and prepare test pilots for flight test





Successful take-off.  
Safe touch-down.

Engineers for engineers.

Higher, faster, further - engineers are continuously optimising aircraft, helicopters or satellites. With lighter-weight composite materials, more efficient engines and more sophisticated electronics and communication systems. At the same time, the quality requirements for production 4.0 are increasing. We take up the challenges from the industry and are your partner for the development of individual solutions for Environmental Simulations, Industrial Heating Systems, Clean Rooms and Climate Solutions. Check in now.



Environmental Simulation • [www.weiss-technik.info](http://www.weiss-technik.info) • Heating Systems • [www.voetsch-technik.info](http://www.voetsch-technik.info)  
Climate Solutions • [www.wkt.com](http://www.wkt.com) • Pharma Technology • [www.weiss-pharma.com](http://www.weiss-pharma.com)

Test it. Heat it. Cool it.

# JACOBS

 is a full service supplier to the Aerospace industry.

With 65,000 employees and 250 offices worldwide, Jacobs' services range from technology consulting to turnkey design/build to operations and maintenance of advanced technical facilities and systems for aerospace, automotive, motorsport, and manufacturing clients. Our capabilities include: strategic planning, program management, simulation, engineering, construction, systems integration, commissioning, lean manufacturing, and plant optimization. Our facility control software, Test SLATE, offers a proven solution for integrating diverse software and systems. We can help you create success with your next project.





W

ith two engineering development models (EDMs) now flying and two more due by the

end of this summer, the CH-53K test program is accelerating at the Sikorsky Development Flight Center (DFC) outside West Palm Beach, Florida. Plans call for the four King Stallion EDM helicopters to log about 2,000 developmental test (DT) hours with an integrated test team from Sikorsky and the Naval Air Systems Command (NAVAIR). Operational testing (OT) will put production-like system development test aircraft (SDTAs) totally in the hands of US Marine pilots and maintainers.

In contrast with traditional, sequential DT-OT, the second Marine Corps pilot to take a cockpit seat in the DT King Stallion is also a qualified operational tester. "This is the earliest in any Marine test program where an operational tester has flown," says Marine Col. Hank Vanderborcht, NAVAIR H-53 heavy lift program manager at Patuxent River, Maryland.

More pilots will be 're-greened' with operational deployments before they return to CH-53K developmental testing.

2 // The first CH-53K engineering development model (EDM-1) flew on October 27, 2015, beginning a planned 2,040-hour flight test program

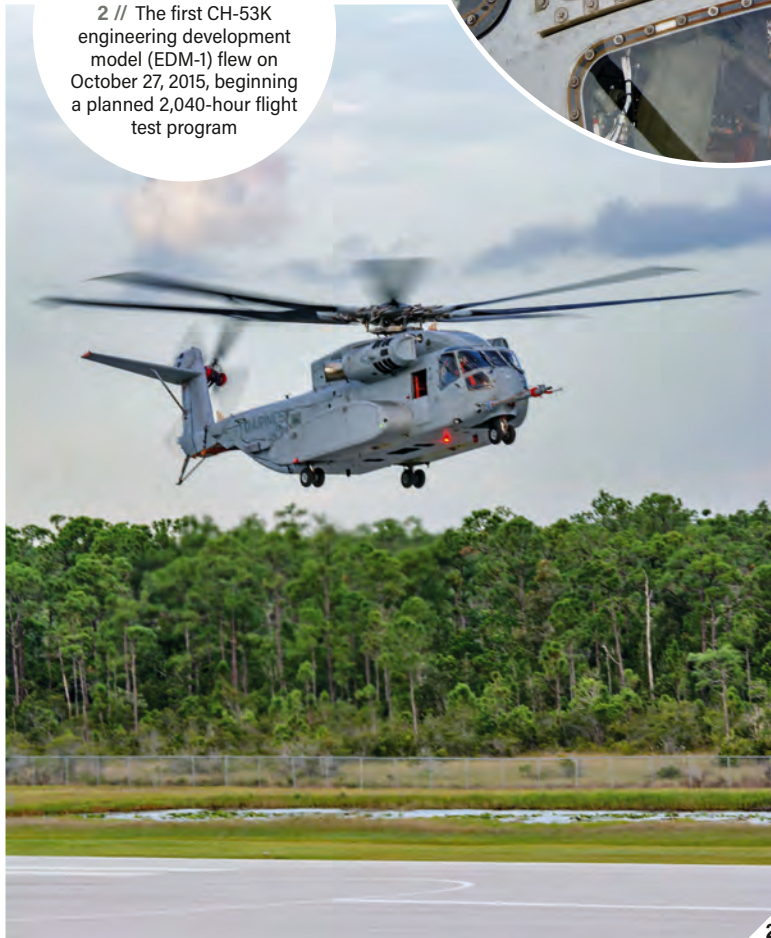

2

## ***"We wanted to develop a helicopter, not a new high-tech instrumentation system"***

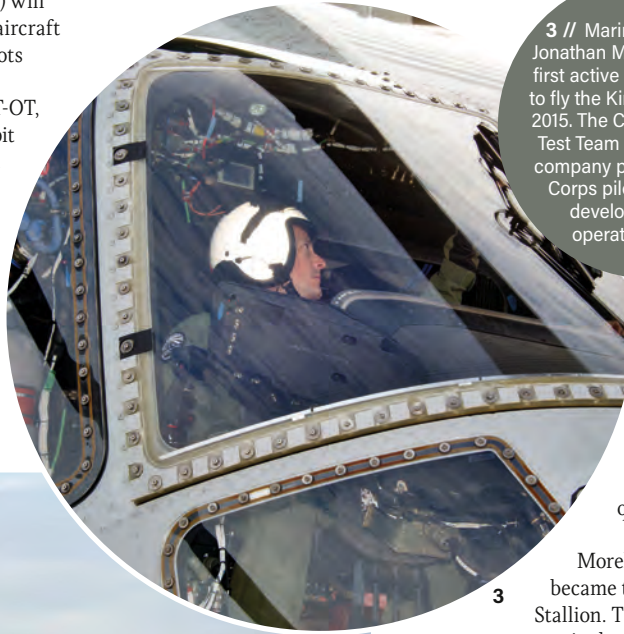

3 // Marine Corps Lt Col. Jonathan Morell became the first active duty Marine pilot to fly the King Stallion, late in 2015. The CH-53K Integrated Test Team will mix Sikorsky company pilots with Marine Corps pilots qualified for developmental and operational testing

3

The lead OT pilot will meanwhile be DT-qualified. "It lets him start flying right away in the DT program and start looking for things they need for OT," explains Vanderborcht. "The whole point is to make the flight test program more efficient. We're already seeing the benefits of having a dual-qualified pilot in the cockpit this early."

Last December, Marine Lt Col. Jonathan Morell from Air Test and Evaluation Squadron 21 became the first active-duty pilot to fly the King Stallion. The integrated test team at West Palm Beach routinely mixes pilots from Sikorsky and NAVAIR. "Now we basically have split cockpits," says Vanderborcht. "It's truly an integrated team. We're distributing people. They're all getting hours in."

By mid-April, King Stallions EDM-1 and EDM-3 had flown 50.1 hours at speeds up to 140kts and altitudes up to 4,000ft. The fly-by-wire (FBW) CH-53K had attained 30° of bank and flown initial entry into autorotation. In its first external load test, the three-hook cargo helicopter lifted and released a 12,000 lb load. According to Sikorsky vice president Dr Michael Torok: "We've gone from direct mode on the flight controls, a very simple flight control mode for the aircraft, to primary flight control system (PFCS) mode, where the real augmentation of the software comes in. We've really started expanding the envelope with the PFCS mode, and that's going very well."

All flight testing so far has been around the Florida DFC, but plans call for testing at Patuxent River and other sites with specialized facilities and environments. Feedback from King Stallion test pilots generates flight control software changes tried first on one of the CH-53K hot benches/systems integration laboratories (SILs) at the Florida DFC, Sikorsky headquarters in Stratford, Connecticut, or the Rockwell Collins Avionics facility in Cedar Rapids, Iowa. "If pilots see something on the aircraft, we try to recreate it on any or all of the SIL benches," explains Torok. "This enables us to investigate the issue without tying up the aircraft."



safety in test > safety in flight

TESTFUCHS

# Test Equipment for Aerospace

Visit us at the **Farnborough  
International Airshow**  
11-17 July 2016, stand 3/A60



Mobile and fixed  
test systems for  
civil and military  
aircraft components

Ground Support Equipment approved for Airbus A350XWB



> Hydraulic Ground Power Unit



> SCS Test Equipment Set



> Waste Line Cleaning Trolley



> Bonding Tester

WWW.TEST-FUCHS.COM

[www.pcb.com/UHT](http://www.pcb.com/UHT)

# UHT-12™ Sensors for Extreme Temperatures

Gas Turbine Engine Research and Monitoring

UHT-12™  
Sensing Element

Total Customer  
Satisfaction  
PCB PIEZOTRONICS

**PCB PIEZOTRONICS** INC.

PCB Aerospace & Defense Division

Toll-Free in USA 866-816-8892

E-mail [aerosales@pcb.com](mailto:aerosales@pcb.com) ■ [www.pcb.com/aerospace](http://www.pcb.com/aerospace)

ISO 9001 Certified • A2LA Accredited to ISO 17025 • AS9100 Certified

- Pressure sensors and accelerometers
- Stable output during thermal changes
- High Temperature to +1200 °F (650 °C)





4 // The fully marinized King Stallion integrates an advanced, high-lift main rotor system and high power density split-torque transmission with fly-by-wire flight controls, large composite structures and integrated avionics to meet the requirements of the Marine Air Ground Task Force

The Stratford flight control laboratory integrates cockpit inceptor control sticks with working avionics, hydraulics and servos. Torok notes: "The SIL is more complex than we have had in the past. It pays off." Software changes derived from testing are tried in the lab and approved by the Sikorsky model development safety committee before migrating to test aircraft.

Marine and Sikorsky pilots flew the King Stallion in the SILs long before the real aircraft. Significantly, EDM-1 made its first flight on October 27, 2015 with all FBW software functionality installed.

"Everything is in there," notes Vanderborgh. "A lot of times, programs want to get the airplane flying and they accept the risk of not having the full-functionality software. The risk of doing that is that you may have to do regression testing as you do flight test."

Regression testing verifies that flight-critical software still performs properly after changes, but historically it has interrupted testing of the RAH-66 Comanche and other FBW aircraft. "In theory, we're not going to have as much regression testing and adding software modules and new functionality as you progress through the flight test program," Vanderborgh adds.

FBW flight testing at Sikorsky typically progresses from unaugmented direct mode, to PFCS for general handling, and ultimately to flight director modes capable of hands-off flight. According to Torok, "Within all that, all the basic characteristics of the aircraft, including stability margin, are being done in direct mode."

EDM-1 testing started in mid-gross weight and mid-center of gravity conditions. EDM-3 is flying in an aft-CG

**4**  
King Stallion  
engineering  
development modes

**6**  
System development  
test aircraft

## KING POWER

Central to meeting CH-53K key performance parameters are three 7,500shp (5,600kW) T408 GE-400 (GE38-1B) turboshafts made and tested at General Electric Aviation in Lynn, Massachusetts. Sikorsky Aircraft chose GE to develop the engine in December 2006, and the GE38-1B first engine to test ran in 2009. A second engine differing only in instrumentation ran in 2010.

The Lynn facility has an engine system test rig to simulate operations in the helicopter, and the first two T408 test engines achieved 8,300shp – 110% of their objective power rating – at the factory. The T408 system development and demonstration phase delivered one core demonstrator engine, five factory test engines and 20 flight test engines to the CH-53K program.

The core engine underwent power turbine stress, loss-of-load, and over-temperature and over-speed testing. The second engine was dedicated to performance and some durability testing. The third T408 went through altitude testing in a GE environmental chamber at Evendale, Ohio. Engines 002 and 003 shared sand-, ice- and bird-ingestion tests, while 004 and 005 were used primarily for durability testing. A 300-hour durability test ran the T408 at sustained full power. Two of the factory test engines will be used for live fire testing by NAVAIR.

Sikorsky integrated T408 flight test engines into the CH-53K ground test vehicle in 2013 with a partial flight readiness release. The engine has so far exceeded 5,500 hours of testing, including 4,500 hours in the factory and more than 1,000 hours on the GTV and the first two flight test vehicles. GE is in negotiations with NAVAIR on a contract to support the CH-53K SDTA aircraft and the King Stallion operational evaluation. The engine maker has delivered nine SDTA engines so far and is on contract to deliver a total of 22 through 2017. GE has also received a request for proposal on T408 low rate initial production deliveries starting in 2018.





# TECSCAN

## AUTOMATED NDT SOLUTIONS FOR INSPECTION OF CRITICAL AIRCRAFT STRUCTURES & COMPONENTS

High precision Ultrasonic Immersion Scanners and NDT software designed to perform inspection of complex composite materials and curved aircraft parts. With TecView™'s coordinated and 3D scanning capabilities, the systems can perform complete tridimensional part inspection.

✉ [www.tecscan.ca](http://www.tecscan.ca) 🌐 [info@tecscan.ca](mailto:info@tecscan.ca) 📞 1.450.641.5876

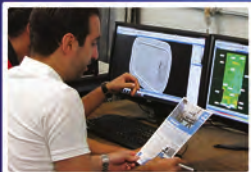

NDT SOFTWARE - TECVIEW™



GANTRY SYSTEMS

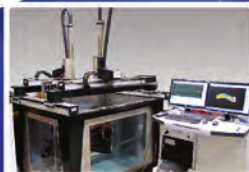

IMMERSION SCANNERS



AIRCRAFT BEARING SCANNERS



AUTOMATED SCANNERS



Avionics Databus Solutions

MIL-STD-1553

STANAG3910/EFEX

ARINC429

AFDX®/ARINC664P7

Fibre Channel

ARINC825

ARINC818

Modules – Software – Systems

# Solving all your Avionics Databus Needs – Right on Target.

[www.aim-online.com](http://www.aim-online.com)

### AIM Contacts:

AIM GmbH - Freiburg  
[sales@aim-online.com](mailto:sales@aim-online.com)

AIM GmbH - Munich Sales Office  
[salesgermany@aim-online.com](mailto:salesgermany@aim-online.com)

AIM UK Office - High Wycombe  
[salesuk@aim-online.com](mailto:salesuk@aim-online.com)

AIM USA LLC - Treviso, PA  
[salesusa@aim-online.com](mailto:salesusa@aim-online.com)



configuration needed for external lift testing. So far, two Marine pilots and four Sikorsky pilots have provided feedback on handling. Torok says, "The comment has been very consistent: 'It's flying just like the simulator.' We've not had to change anything. We're off to very good start in that respect."

### HEAVY LIFTING

The 88,000 lb (40 metric ton) CH-53K started as a low-risk evolution of the 73,000 lb (33 metric ton) CH-53E, defined by a 2004 Joint (service) Operational Requirements Document. The Marines needed a replacement heavy lift helicopter to carry armored Humvee vehicles and other equipment of the ship-launched Marine Air-Ground Task Force. Marine requirements and advancing technology evolved the CH-53K into an all-new aircraft with high-lift main rotor blades, high power-density split-torque main transmission, FBW flight controls, large composite structures, electronically controlled engines, and an integrated cockpit with digital connectivity. The King Stallion, with its three General Electric T408 engines, is meant to haul 27,000 lb (12 metric tons) of sling cargo over 110 nautical miles (200km) to high-and-hot landing zones, effectively three times the payload/range performance of the CH-53E packed in the same deck footprint.

CH-53K system development and demonstration began in 2005, but technical challenges in the ambitious drivetrain and programmatic issues slipped first flight

***"What we've seen so far is excellent correlation between the two flight-test vehicles, which gives us a lot of confidence"***

from the planned 2011 date. King Stallion EDM-1 made its first flight in October 2015 and EDM-3 in January 2016. "When we started flying the second aircraft, we were looking to see how was the data going to compare," says Col. Vanderborcht. "What we've seen so far is excellent correlation between the two flight-test vehicles, which gives us a lot of confidence that the manufacturing stability is there and the behavior is predictable."

EDM-1 and -3 are identically instrumented for envelope expansion and structural qualification. "Because they're instrumented the same, we have flexibility," says Dr Torok. "We can do all the envelope expansion on either aircraft. They will lead the fleet." Sikorsky upgraded computers and processes at its DFC to make the most of familiar flight test instrumentation and handle the enormous amount of data generated by the King Stallion. According to Torok, "We wanted to develop a helicopter, not a new high-tech instrumentation system. At the core we have an instrument set we wanted to stick with. On top of that, this aircraft is instrumented far more than our prior programs.

"The core is proven technology, but the increase in quantity had us upgrade our processing a bit and include onboard processing." The Sikorsky DFC has telemetry facilities to downlink data from multiple flight tests simultaneously. However, much of the CH-53K data from dedicated test instrumentation and the aircraft databus is recorded on board. Torok notes, "We do some processing of the data on the aircraft before landing. When we come in at the end of the day, the flight test engineers can preview that data."

Sikorsky opened a new facility at the DFC in 2012 to assemble and support King Stallions. EDM-2, now turned over to flight test for instrumentation, should begin ground runs in May and make its first flight in early summer. It will be used for propulsion testing and to complete performance tests. EDM-4, now in final assembly, will be the avionics/mission systems test aircraft.

The flight test fleet is backed by an anchored ground test vehicle (GTV) that has most of the equipment found on the flying aircraft. The GTV began turning its rotor head without blades attached in

5 // General Electric Aviation in Lynn, Massachusetts, delivered five factory test and 20 flight test engines to the CH-53K program. Delivery of 22 SDTA engines is underway (GE Aviation)



5

## CH-53K KING STALLION

December 2013 and started shakedown testing with blades installed in April 2014. It revealed gearbox failures in January 2015, tested fixes in June 2015, and by April 2016 had accumulated more than 350 operating hours, including a 50-hour pre-flight acceptance test.

System-level verification testing now underway aims to put twice as many hours on the GTV as on the flight test vehicles. At the 200-hour mark in the flight test program, the GTV will be torn down. "We'll be taking everything apart and doing a major inspection on all the components," explains Torok.

Changes made on the GTV migrate to the flight test vehicles, and long-term reliability testing will put even more hours on the grounded King Stallion. The GTV is expected to run some 650 hours before it is loaded onto a C-5 or C-17 airlifter for transportability tests and flown to China Lake, California, for live-fire testing with threat weapons in fiscal 2019. Until then, the GTV continues to give the integrated test team a valuable training device. "All the pilots spend significant time in the GTV before they go up and fly in the aircraft," says Col. Vanderborght.

### MARINE INPUT

Four King Stallion EDM helicopters will be followed by six uninstrumented, near-production standard systems demonstration test articles (SDTAs) used for both developmental test and operational test and evaluation. The first four SDTA helicopters under contract are in final assembly at West Palm Beach. Long-lead items for SDTA-5 and -6 are on order and delivery contracts are being negotiated.

DT data collected with EDM and SDTA helicopters will drive improvements in SDTA aircraft assigned to the Marine Corps operational evaluation (OPEVAL). SDTA-1 through -4 will undergo OPEVAL with Marine crews and maintainers at a location to be determined. CH-53K maintenance manpower required in the fleet has to be equal to or less than that required by today's CH-53E. A final manpower estimate report will document the validated requirements upon completion of OT.

Active-duty Marine maintainers provided input at the CH-53K design stage and continue to do so at the DFC. Col. Vanderborght recalled that the tail rotor gearbox on the legacy CH-53E vertical fin provided little room for hands to scrape off and reapply sealer coating. Maintainers



6 // The Marine CH-53K is designed to carry up to 36,000 lb of internal and external cargo, including Air Force cargo pallets and up to three discrete external loads totaling 27,000 lb on three belly hooks

asked Sikorsky engineers to extend the gearbox legs for easier access. "That's just one small example of the impact the maintainers have had on the CH-53K design."

Supportability improvements continue during flight test: "We've had one change," explains Dr Torok. "We've relocated one of the avionics boxes. That's already been moved and proved." He adds: "We're going to change a few things in the man-machine interface for the maintainers. One is on the engine cowling; they're looking at the hand grips as you're climbing on the aircraft."

A CH-53K full-rate production decision is expected in the second quarter of fiscal 2017. Marine Corps plans call for 200 CH-53Ks to outfit eight active-duty squadrons, two reserve squadrons, one fleet replacement squadron and assorted test units. Initial operational capability remains scheduled for fiscal 2019 and full operational capability culminates with the last active unit equipped in fiscal 2029.

The King Stallion engineering development models will be tested with full Marine loads carried in

representative environments, and two of those aircraft will be used for follow-on test and evaluation. "We haven't gone to the edges of the envelope," says Dr Torok, "but the aircraft is performing as we've expected. There's been nothing that changes the configuration." \

## 200

CH-53Ks will give the US Marine Corps full operational capability

## 27,000 LB

Weight that the King Stallion can lift over 110 nautical miles to meet the Marine Corps' heavy lift replacement key performance parameter



# UNHOLTZ-DICKIE CORP.

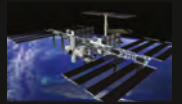

## Vibration Test Solutions...

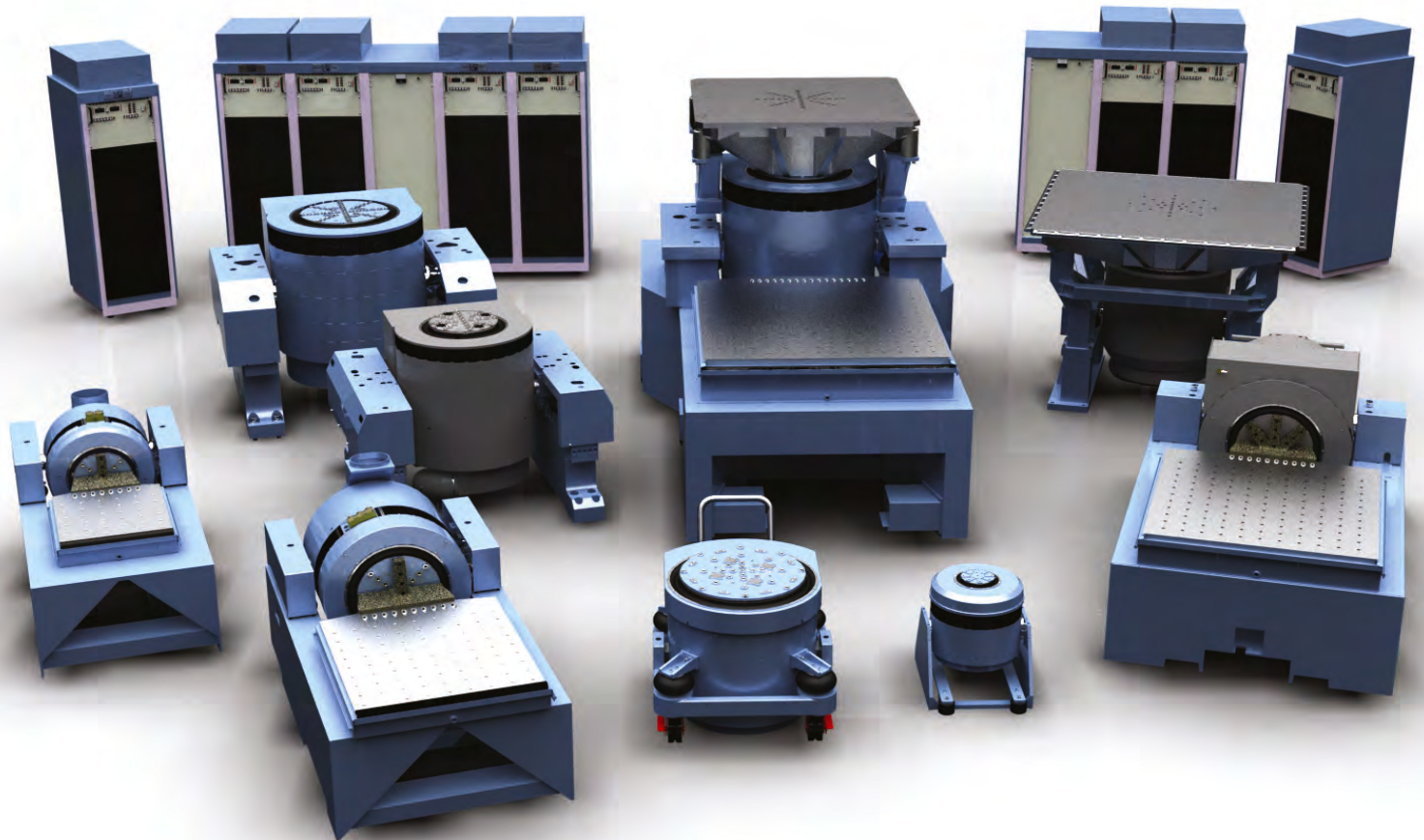

...for over 55 years!

- **Electrodynamic Shakers**
  - 50 - 55,000 lbf (0.2 - 245 kN)
  - 2 & 3 inch (51 & 76 mm) Stroke
- **PERMALINE Slip Tables**
  - Quick & Easy Rotation
  - Guidance Bearings
  - Building Isolation
- **Head Expanders**
  - Square, Round, Rectangular
  - Guidance w/ Auto-Load Support
- **Power Amplifiers**
  - Air Cooled, IGBT Technology
  - >90% Efficiency, 15-720 KVA
- **APEX SL Controllers**
  - 4, 8, 12, 16 Input Channels
  - Sine, Random, Shock, SRS, SOR
  - Res Dwell, ROR, Time History
  - DATAcq & Analyzer
- **Instrumentation**
  - Signal Conditioners
  - Accelerometers



World Headquarters:  
West Coast Division:  
European Division:  
Website / Email:

Connecticut, USA  
California, USA  
Germany  
[www.udco.com](http://www.udco.com) / [info@udco.com](mailto:info@udco.com)

Tel: (203) 265-3929  
Tel: (310) 276-0275  
Tel: +49 8031 234 734



**FOKKER 100**

// NUNZIO NICOLA CACCAVO



# Team. SPIRIT



1 // ABE-NG modifications included a fighter nose pod, two wing stores and a recce belly pod



# it

A complex international program to secure a Supplemental Type Certificate for a Fokker 100 modified as a flying testbed provides a good lesson in effective cooperation

**T**he *Essais en Vol* (flight test) division of the French General Directorate for Armament (DGA), which is the government agency responsible for the program management, development and procurement of weapon systems for the French Armed Forces, is in the process of replacing its existing flying testbed fleet, which currently consists of six rather old Dassault Mystère 20 aircraft. To do so, it has contracted with Sabena Technics to provide a modified Fokker 100 for what the DGA describes as the ABE-NG (Avion Banc d'Essais - Nouvelle Génération) program. In turn, Sabena Technics teamed up with Fokker Services, the Type Certificate (TC) holder of the F100, to help achieve certification with a DOA-to-DOA agreement - Sabena Technics as STC holder and Fokker Services responsible for external changes and their structural consequences.

The aircraft in question, a Fokker 100 (F28 Mk0100) powered by Rolls-Royce Tay 650 engines that had previously served in the Régional airline fleet operating Air France flights, was immediately dubbed Pinocchio by the test team because of its peculiar nose.

This was the result of a set of modifications that involved adding a fighter nose pod borrowed from the Rafale fighter, two new underwing hard points with dummy MICA missiles pods, and a recce pod positioned





**“At first glance one could say it’s a Part 25 fighter”**

**4**

The number of nationalities that make up the test crew

**43**

The number of test flights carried out to secure certification

**120**

Total flight hours

**300+**

The amount of stalls performed during testing

2 // Testing in the area of Bordeaux allowed ATC and telemetry support from DGA Flight Test in Cazaux

under the fuselage. The work was completed by several structural modifications and reinforcements, internal test benches, and extensive cabling to connect sensors, benches and operator stations. At first glance one could say it’s a Part-25 fighter, but to the test team it was simply ‘Pinocchio’.

The effort required for the DGA-requested EASA certification was impressive: aerodynamic and structural modifications required the STC to be almost a complete recertification of the aircraft – a derivative, as such.

Managing the program was a particularly complex task as it required the coordination of different and distant engineering centers between France and the Netherlands. However, the program is proof of how a strong team integration effort can help shorten a large program.

Work encompassed a feasibility study, preliminary and extensive simulation and wind tunnel testing, the modification and ferrying of the aircraft, and the flight test campaign. All certification subjects were included – performance, handling qualities, stalls, avionics, flutter and, to make things more complicated, many tests had to be repeated according to the aircraft’s various external configurations.

**FLIGHT TESTING**

The feasibility study highlighted a challenging situation: very few Part 25 aircraft have been equipped with wing stores and a fighter nose, so the first step was to perform an extensive aerodynamic investigation in the wind tunnel and via CFD simulation. The results provided very useful information and helped determine the position and design of hard points and the nose fairing.

Confident in the results obtained from the preliminary analysis phase, the flight test campaign

was designed according to the various aircraft configurations (with or without fighter nose, missiles or recce pod, for example) and resulted in a predicted list of more than 44 successful flights.

The subjects covered by the flight test campaign were: shakedown/instrumentation check; envelope openings; position error correction (PEC); stalls; flutter/aeroelastics; flight handling; avionics; and performance.

Before the actual campaign started, attention was given to team-building activities: three parties were to be involved and later a fourth team from EASA would join. Team-building included two sessions of simulator rehearsal to revise flight test techniques and onboard responsibilities.

Modifications were carried out at the Sabena Technics site in Dinard, France, where ground vibration testing also took place to pave the way for the later flutter tests.

The first flight took off from Dinard, with the aircraft flown to Bordeaux, where the full campaign would take place. Bordeaux was chosen as it is the location of Sabena Technics’ engineering and flight test facilities, as well as for its proximity to the DGA Flight Testing ground station at Cazaux Air Force Base. The Bordeaux site also offered dedicated ATC and telemetry, essential for performing flight handling and flutter tests. Telemetry data was monitored by Fokker specialists at the Bordeaux telemetry room, with support from Cazaux



3

3 // The F-100 ABE-NG at Sabena Technics facility in Bordeaux



DGA Flight Testing, which covered the entire test area and included an intercom downlink.

Once installed at Bordeaux, the ABE-NG began a tight schedule of tests, with flights always flown with a joint team from Sabena Technics, DGA Flight Testing and Fokker Services. The tests were divided into configuration-related blocks, each with its own flight envelope opening for the four external configurations, from the basic aircraft to all stores installed.

A number of specialists continuously received and verified the data, both in Bordeaux and at Fokker Services HQ in Hoofddorp, the Netherlands. Time-critical data analysis was carried out on a daily basis and the results were fed back to the program management to reconfirm the need for all the tests initially planned. In fact, as a result of this system of negative feedback control, the total number of flights was limited to just 43. Further support came from the local climate – good



4 // Instrumented captain's control wheel and flight test display

5 // Joint flight test crew (from left): Benoit Douxchamps (Sabena Technics); Ton Nieuwpoort, Dirk van Os, Nunzio Nicola Caccavo, Sjoerd Postma (Fokker Services); Thibaud Brouze, Patrice 'Polo' Perlato (DGA Essais en Vol)

weather conditions are present almost all year long in Bordeaux and this helped limit the number of missed flight tests due to adverse meteorological conditions.

**FLIGHT TEST PROVISIONS**

In addition to standard data acquisition sensors, the aircraft was equipped with a number of flight test provisions required to deal with different aspects of the campaign, which were provided by Sabena Technics. One of the first anticipated issues to be solved was the validation of the aircraft angle-of-attack vanes and pitot tubes, as they are positioned in an area where the airflow may have been potentially altered by the installed fighter nose. To cope with this, a swivel-head air data boom was installed on the left-hand wing tip. It included an air data computer and provided comparative data for angle of attack, slip, total and static pressure, and total

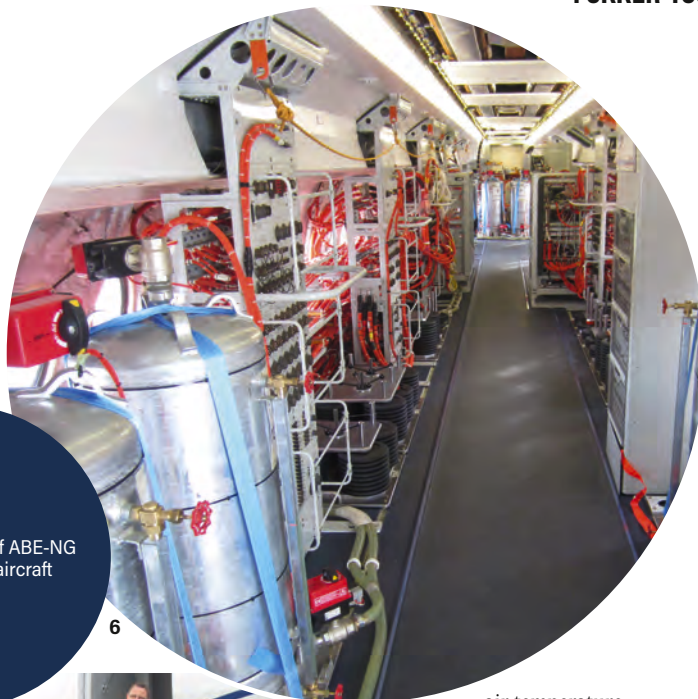

6 // Interior view of ABE-NG Fokker 100 test aircraft



air temperature. The captain's control wheel and rudder pedals were equipped with force sensors, while classic tufts on the upper sides of the wings and lateral sides of the pylons were monitored by cameras installed inside the cabin and in the flap track fairings on both sides. A water ballast system helped to change the center of gravity (CG) in flight, avoiding dead ground time.

Finally, flight test displays were installed in the cockpit and at the three flight test engineer positions to enable the test crew to see the parameters not normally displayed in a transport aircraft, but required for correct test execution without ground confirmation.

**STALL TESTING: A KEY CHALLENGE**

As well as some common administrative issues, risk mitigation was the main challenge of the program. During the original F100 type certificate flight test campaign, a serious incident occurred when a prototype entered a deep stall while performing stall tests with an open-loop pull technique as required by regulations.

This event resulted in studies and discussions to identify alternatives other than the installation of expensive recovery means such as spin chutes or tail rockets, which, in addition to their considerable expense, would have generated structural and aerodynamic modifications altering the aircraft's profile. Therefore, during stall tests (but also though the entire campaign), a gradual build-up approach was followed, starting tests with mid-CG and moving toward the envelope boundaries. Additionally, the test sequence went from straight, low entry-rate stalls to turning high-rate ones, always monitoring the angle of attack against calculated and historical values. The maximum aft CG position could be limited due to the specific ABE-NG configuration.

Fortunately the open-loop pull technique is no longer required by regulations, and with all the above mitigations, the stall test campaign could be performed

7 // A swivel-head air data boom (ADB) was installed on the left-hand wing tip



9 // The air data computer inside the ADB recorded angle of attack, slip, total and static pressure, and total air temperature

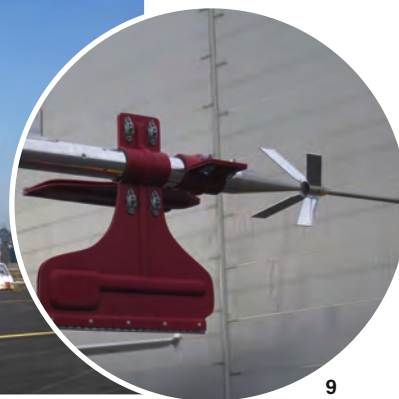

8 // Flight test working area around Cazaux Air Force Base



with an acceptable safety level and without need for recovery means – the only real limit being what the human stomach could withstand.

Once the handling qualities tests were completed, the team hosted representatives from EASA to witness a selection of previously performed tests. In fact, EASA flight test personnel were involved from the beginning of the campaign, advising on engineering choices and participating in the preliminary phase, including the simulator rehearsals. This facilitated common and complete understanding of the program and avoided unplanned changes. EASA colleagues also gave useful advice on the correct execution of some tests, such as acceptable stall identification methods.

Four witnessing tests were performed in two phases of the campaign, all giving positive feedback and encouraging the team to continue.

## DATA ANALYSIS AND CERTIFICATION

After completion of the campaign, all Fokker Services' specialists worked hard to complete the data analysis and prepare the reports that were to be used for certification. Fokker Services provided feedback to Sabena Technics in the form of technical reports, consistent with the two-way communication that marked the cooperation between the two DOA companies at all times.

Sabena Technics later submitted and followed up all the information to EASA, which eventually granted the company with the Supplemental Type Certificate in October 2015.

So what key lessons were learned? Strong cooperation based on mutual trust of certification stakeholders makes it possible to reduce the effort of a large modification – even when switching from a transport aircraft to a virtual 'fighter'. This was achieved without compromising the quality of data collected or increasing the stress levels of the team members involved. Team building and risk mitigation resulted in safe and effective 'right first time' test execution. The project was also positive from a human interaction perspective: individuals learned from each other and different cultural backgrounds made for a more interesting experience, especially during time off work.

While perhaps this cannot be labeled as innovative technology, the cooperation between Sabena Technics, Fokker Services and DGA Flight Testing could perhaps feature in test pilot school manuals under a chapter headed 'Effective teamwork'. \ \

*Former pilot in the Italian Air Force, Nunzio Nicola Caccavo is a flight test engineer with the Engineering, Projects and Fleet Support team at Fokker Services in the Netherlands*





**180+**  
EXHIBITORS  
EXPECTED

# THE WORLD'S LARGEST METEOROLOGICAL EXHIBITION JUST GOT BIGGER STILL!

If you need better weather prediction  
and climate measurement technologies  
or services, you'll find them here!

**FREE TO ATTEND!**

# Meteorological TECHNOLOGY WORLD EXPO 2016



27, 28, 29 SEPTEMBER 2016

MADRID **SPAIN**

**NEW  
VENUE  
FOR 2016!**

You can register online to guarantee your **FREE FASTTRACK** entry code

[www.meteorologicaltechnologyworldexpo.com](http://www.meteorologicaltechnologyworldexpo.com)



**SPACE**  
**TECH EXPO**  
USA

*May 23 - 25, 2017*  
*Pasadena, CA, USA*



***CONTACT US TODAY FOR E***

[www.spacetechempo.com](http://www.spacetechempo.com)

[info@spacetechempo.com](mailto:info@spacetechempo.com)





*Oct 24 - 26, 2017*  
*Bremen, Germany*

# *one show*

---

# *two continents*

**The world's engineering and manufacturing  
meeting place for space and defense!**

Connect with some of the industry's leading companies showcasing the very latest testing and measurement capabilities, from NDT, motion simulation, environmental testing and vibro-acoustic, to electronic and electrical testing, cable/wire testing, data acquisition, metrology and more.

***EXHIBITION OPPORTUNITIES***

[www.spacetechempo.eu](http://www.spacetechempo.eu)

[info@spacetechempo.eu](mailto:info@spacetechempo.eu)

# LEARN MORE ABOUT OUR ADVERTISERS **NOW!**

**FREE SERVICE!**



Visit [www.ukipme.com/info/tea](http://www.ukipme.com/info/tea) to request exclusive and rapid information about the latest technologies and services featured in this issue

**Aerospace**  
**TESTING**  
INTERNATIONAL

[www.ukipme.com/info/tea](http://www.ukipme.com/info/tea)



# ELECTRODYNAMIC VIBRATION TESTING

An electrodynamic shaker for vibration testing has a wide range of frequencies, a large table and accommodates tests of complete assemblies

The ES series electrodynamic vibration shakers manufactured by Dongling Technologies can simulate various dynamic environments and produce force ratings from 100N to 600kN. The 600kN electrodynamic vibration shaker was released in 2015. The first electrodynamic unit was configured with a large head expander and large slip table with high overturning moment capability.

The large 4.5 x 4.5m slip table is capable of handling a maximum payload of 20,000kg and has a maximum overturning moment of 2,000Nm. As a result, the 600kN electrodynamic vibration shaker has a wider operating frequency range, from 2Hz to 2,000Hz, compared with the alternatives of a multishaker or hydraulic shakers. This also satisfies the force and frequency response range needs of dynamic environmental tests. Moreover, the electrodynamic vibration shaker removes the need for synchronous operation of multiple units due to force limitations imposed by a single shaker.

The 600kN electrodynamic vibration shaker has been widely applied in aerospace, as shown by the tests of a complete satellite,

a lunar rover, space station components and large rockets. The size and performance of this vibration test system is remarkable because, for the first time, a fully assembled product test can be undertaken, while in the past only a component testing was available.

During testing, a fixture and test article often have different connection boundary conditions, which may result in unrealistic tests and further lead to a specimen's inconsistent response in practical situations. Compared with component-level testing, full assembly tests can easily solve these product failure problems that might not



1 // The 600kN electrodynamic shaker with a test specimen engine mounted – demonstrating the large working area available

## TECHNICAL PARAMETERS

- Sine force rating:** 600kN (134,885 force lb)
- Random force rating:** 450kN (101,164 force lb)
- Shock force rating:** 1,500kN (335,000 force lb)
- Slip table dimensions:** 4.5 x 4.5m (14ft 9 x 14ft 9in)
- Head expander dimensions:** 4.3m<sup>2</sup> (14ft<sup>2</sup>)
- Maximum payload:** 20,000kg (44,000 lb)
- Displacement:** 61mm peak to peak (2.4in peak to peak)

2 // A head expander is added to the original table to allow extension depending on testing needs and specimen size



otherwise be encountered if only individual components were tested. Assembled test specimens can better simulate operating conditions of all components in unison, including connections, contacts and friction between all parts. Also, all tested components will receive more practical stiffness and damping; avoid distortion caused by the fixture; remove the challenges of proper fixture design and mounting; and achieve a more natural response.

Large electrodynamic vibration shakers can be applied to the dynamic environmental tests of all kinds of large-scale spacecraft assemblies. This type of shaker creates a more realistic simulation environment and achieves higher control accuracy. Additionally, the specimen installation process is closer to actual working conditions, which effectively avoids over-testing and can shorten cycle times. In this way, a product defect can be found in advance at the laboratory. Furthermore, it can provide more accurate and authentic data for design and manufacture, and help to improve the product reliability. \\\

READER INQUIRY 101

FREE READER INQUIRY SERVICE

DONGLING TECHNOLOGIES

To learn more about this advertiser, visit [www.ukipme.com/info/tea](http://www.ukipme.com/info/tea) NOW!

# CALIBRATION DATA CLOUD

The B&K online information center gives a single place to store and recall vital data and administer recalibration of instruments



The most exciting task for engineers may not be calibration, but it is a necessary evil of their world. It guarantees that measurements are accurate, and by doing so, ensures peace of mind. An instrument will almost always be able to give a reading, so only regular checks against a known standard can ensure the instrument gives the results it should – ones that can be trusted. Calibrations are the only way to actually prove that measurements are valid, whether it is auditors checking compliance to ISO or OSHA standards, OEM customers checking quality procedures, or even inquiries from legal agencies. Calibration certificates are the only proof, and neglecting them can affect the legal compliance of the whole company.

But calibration doesn't always bring peace of mind; it's a headache! Who wants to spend ages organizing it all? Test engineers and technicians must remember to calibrate all of their instruments at the right intervals. With many transducers and analyzers to track and take care of, it is easy to forget one, and a drain on engineers' time, which is lost to administrative work. After sending instruments off for calibration, engineers have to file calibration certificates and charts. And often, they neglect to file them and then desperately search for the documents when the auditors come, or when they need to input the instrument's latest correction information into their most recent analyses.

Because this administration work wastes time and increases the risk of erroneous measurements creeping in, Brüel & Kjær has put it all online. Now, users can take a transducer from a drawer and simply search online for its serial number to find the calibration information – such as the sensitivity or standard compliance. Or, users can log in at [bksv.com](http://bksv.com) and see all their transducers and analyzers listed. They can click on any one to get the vital information

from any year going back to the original factory calibration.

Having this single, paperless place to find all calibration information makes it simple to administer all activities relating to calibration. A user can add other instruments too, so even if they are not all from Brüel & Kjær, the user can still view all their assets in one location. The clear overview has a color-coded system that indicates when an asset is nearing its calibration date with clear red indicators if a calibration date has been missed. Users with many assets can find individual ones easily using search functions.

With a clearer overview, it is easier to schedule and plan tests around calibrations, since it is clear to see when microphones or accelerometers will be out for calibration. Instead of searching through individual paper files, there is a single place online where users can also see all of the Brüel & Kjær calibration services offered, select the best for them, and order calibrations or repairs.

The single calibration dashboard also means that when the auditors come, the certificates are all there ready to show them. There's no last-minute panicking to find calibration certificates – or even to get instruments calibrated in time! And in future, the calibration cloud is set to expand so that even if a company has more than one location with Brüel & Kjær equipment, administrators will be able to see the assets across all sites within the company.



**1 //** To find the calibration information of a single transducer, users simply type its serial number into the online calibration data service on Brüel & Kjær's website

**2 //** Any type of sensor or transducer whether from B&K or not can be entered into the online service

A centralized, digital resource vastly simplifies inputting calibration data into analyses. Users copy asset specifications to input them into the analysis software on the same computer. If testers need to know information such as a microphone's frequency response curve, one simply looks online. For analyzer calibration, users can get instant access to their many parameters whenever needed and it is easy to see the standards to which any instrument is calibrated.

A single place for data also assists with trend analysis. As instruments gradually drift over time, their periodic calibrations track the movement of the drift. Online, users will be able to see the precise calibration performance going right back to the factory. With this oversight, users can plan when instruments will become too inaccurate and need replacing, and therefore schedule their future purchases. Users can also look back at the calibration history, so in the event of any questions over the integrity of a measurement they can see the trend and prove when the instrument was in-bounds.

The online calibration data service, created in response to many customer requests, provides a simple, single place for calibration activities, and ensures customers' calibrations are under control. Removing the mundane work means calibration thus requires minimal effort. Data centralization with an overview gives them the peace of mind that all of their measurements are valid, and up to the standards necessary for whatever external compliance they must fulfill – with no nagging doubts. \\\

READER INQUIRY 102

FREE READER INQUIRY SERVICE

BRÜEL & KJÆR

To learn more about this advertiser, visit [www.ukipme.com/info/tea](http://www.ukipme.com/info/tea) NOW!



# Aerospace TESTING INTERNATIONAL

- › All the latest news ‹
- › Expert opinion ‹
- › Exclusive features ‹
- › Video gallery ‹
- › Industry interviews ‹
- › Recruitment section ‹
- › Digital edition and magazine archive ‹



WWW.AEROSPACETESTINGINTERNATIONAL.COM

# En'Urga Inc.

Nozzle testing made easy!



Aero Engine Nozzles  
Irrigation Sprays  
GDI/Diesel Injectors  
Inhalers  
Paint Guns  
Tablet Coaters

SETscan Optical  
Patternator  
Velocimeters  
X-Spray Diagnostic

1201 Cumberland Avenue, West Lafayette, IN, 47906 • [www.enurga.com](http://www.enurga.com) • [info@enurga.com](mailto:info@enurga.com) • 1-877-825-6100

## Aerospace Testing International FREE APP now available!



GO TO THE APP STORE  
NOW TO DOWNLOAD THE  
APP FOR YOUR TABLET



# DOWNLOAD NOW!



READ  
ANYWHERE,  
WITHOUT  
WI-FI!

RECEIVE THE  
LATEST ISSUE  
WEEKS BEFORE  
THE HARD COPY  
IS AVAILABLE

PLUS

THE LATEST NEWS & FREE MAGAZINE ARCHIVE



# A320 HYDRAULIC SYSTEMS TESTING

Airbus and Test-Fuchs have partnered to create a hydraulic testing solution for a new single-aisle production line without interruption to other key production tasks

The fundamental requirement for new hydraulic testing equipment for the Airbus A320 production line was that it fit under existing aircraft jigs and inter-jigs, where there was a maximum clearance height of only 900mm. The unit was designed, manufactured and put into service to test assembled fuselages. Extreme flexibility was important. The hydraulic test is performed on several aircraft production stages, with very short times between the test stations. The complete hydraulic test has to be performed within 90 minutes, fully automatically.

Test-Fuchs, with Airbus, solved the design challenge by creating hydraulic test equipment comprising four main units.

First, the hydraulic power unit (HPU) supplies a staggering 800 liters of hydraulic fluid per minute. It consists of four motor pump units, two main hydraulic fluid reservoirs, each with 2,000-liter capacity, and two pneumatic compressors (combined with four 32-bar pressure vessels of 2,000 liters each). An electrostatic filter for waste air ventilation is fitted within a duct for approximately 4,500m<sup>3</sup>/h up to the building roof. Four switch cabinets manage a power supply of 234kVA. To take full advantage of the space in the facility, HPU installation is on the ground floor under the logistic jigs in a sound isolation room. Connection to the other main units is achieved using a widespread tube system in the basement ducting of the assembly hangar.

The second main component is the connection unit (CU), which distributes and regulates the hydraulic fluid flow at different pressure levels to all circuit connections in the aircraft fuselage. This important and enormous component weighs 10 metric tons, measures 6 x 6m, and moves on rails between two test points and a maintenance station. A 16m energy, control cable, and

hydraulic hose assembly provides flexible connectivity throughout this range.

Available space limited the maximum unit height to 900mm under the aircraft jigs on the ground floor. Test-Fuchs designed special hose towers that can be lifted into an upright position. They feature integrated hose drums for low- and high-pressure circuits and are easily connected to the single aircraft hydraulic connection interface, 3m above the ground floor. On the first floor of the aircraft jigs, the fold-out hose towers slide perfectly through the jigs with just millimeters of clearance space.

The third main unit is three individual particle measurement trolleys. Their task is to provide fully automated measurement of the aircraft's hydraulic circuits at 36 outlet ports. They send data to an HMI where the state of the hydraulic tube system can be seen on a screen. Furthermore these units return all hydraulic fluid to the main reservoir of the HPU via dedicated pipework and hoses. In this way the medium is used in a closed loop hydraulic circuit.

The fourth main component is the HMI, which provides fully automated control of the test equipment system's complex tasks. Designed and engineered as a mobile unit in a stainless-steel case, it is equipped with large screens, keyboard, trackball and blotting pad, all designed in accordance with

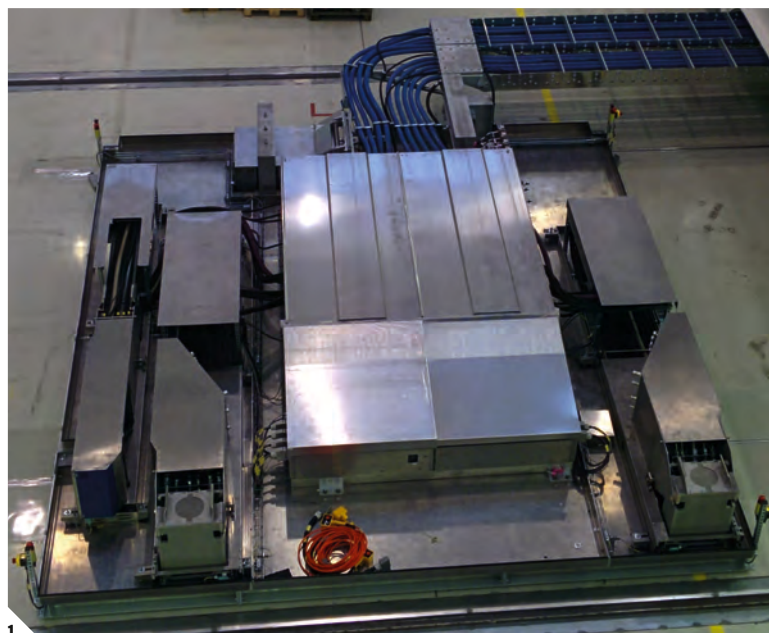

1

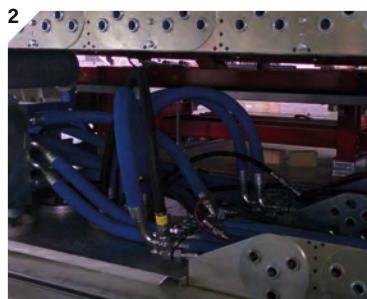

2

European ergonomic guidelines. It contains the control and measurement PC where all the test data are collected and stored.

The automatic tasks performed on the aircraft are flow and leakage tests using air (up to 30 bar), hydraulic system filling, leakage tests at low and high pressures, system flushing, particle measurement and contamination checks, and draining the fluid from aircraft pipes.

In addition to the technically sophisticated requirements, space and time were critical issues. After a thorough study of the premises and possibilities, Test-Fuchs engineers solved the space limitations by designing most of the units to be on wheels or rails so that all the test equipment can be moved around safely and quickly. Practical storage of hoses and cables avoids accidents among personnel and saves production time. \\\

1 // The mobile connection unit (CU) for hydraulic fluid distribution to the aircraft

2 // The connection between the connection unit and the hydraulic supply

READER INQUIRY 103

FREE READER INQUIRY SERVICE

TEST-FUCHS

To learn more about this advertiser, visit [www.ukipme.com/info/tea](http://www.ukipme.com/info/tea) NOW!

# LANDING GEAR TEST SYSTEMS

Testing landing gear designs starts well before aircraft prototypes are built. A customized testbed could speed up the process and provide early results

For over 40 years FGB has developed and manufactured customized turnkey testbeds and their components (servohydraulic, electromechanical) for its customers. The company can undertake, in-house, the complete construction process required for the delivery of complex test systems, including manufacturing, assembly, control cabinet construction and software.

Recently FGB delivered an electromechanical landing gear testbed to examine and ensure the gear's proper functioning under realistic conditions before production begins. The machine is innovative and versatile, with unique performance characteristics and a simple operation.

Testing aircraft landing gear is essential prior to production to provide high-quality structural components. Use of a testbed represents a market advantage for landing gear manufacturers.

Because highly dynamic test procedures do not occur in this application, servohydraulic drives can be omitted and benefits can be gained from using electromechanical actuators. These include easier handling of the system, and its operation is more energy efficient compared with servohydraulics.

The basic mechanical structure is a very rigid four-column frame, which also guides the main head. During tests the chassis is positioned between a base plate and the main head. The latter has an adapter plate to hold the load vertically. Depending on the construction of the testing machine, it can generate considerable torque and shear forces even with a purely vertical application of force.

Test procedure programs are stored in a sequence controller that controls the operation of the machine to give specific loadings to the landing gear being tested.

One can choose between displacement and loading control and it is possible to switch these within a test cycle. Limit monitoring is always active with preset specific values.

The acquired data for testbed lift, force and specimen responses provide the specific testing results. As well as various individual values, for example, the contact force and characteristic curve values can be preliminarily derived and measurement results can be easily accessed in a variety of output formats.

In addition to a stored movement profile, specific test positions can also be analyzed. Various load limit values can be set in the movement profiles. Additional measurement channels can be set up to acquire information about extra criteria of the test article such as hydraulic oil or surface temperatures of the shock absorber. The data collected enables the generation of valid reports about the behavior of the test specimen. Because of the system setup, speedy fault analysis can be undertaken in the event of problems. \\\

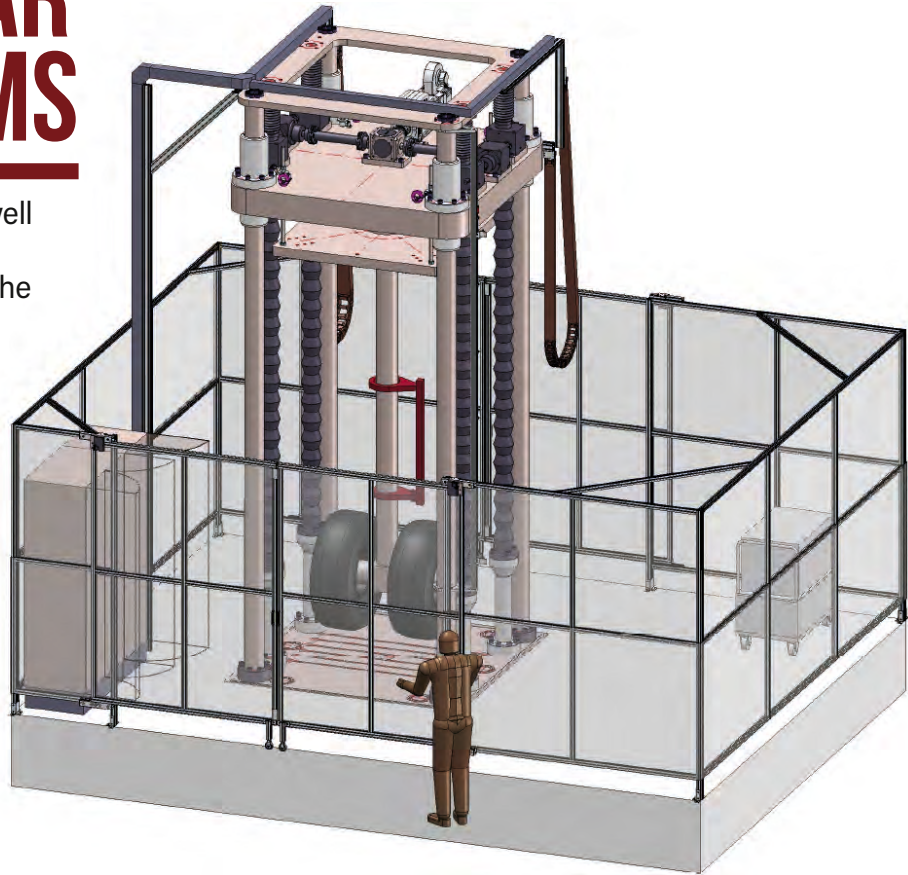

1 // A rendering of the landing gear testbed designed and constructed by FGB Steinbach

## TECHNICAL DATA ON THE TESTBED

### z-axis

Test load vertical: 1,000kN  
Test distance: 800mm  
Operating height of the adapter plate at main head: 1,000-4,000mm

### x-axis

Load support at main head: 20kNm  
Torque support at main head: 20kNm

### y-axis

Load support at main head: 5kN  
Torque support at main head: 5kNm

READER  
INQUIRY  
104

FREE READER INQUIRY SERVICE

FGB STEINBACH

To learn more about this advertiser, visit [www.ukipme.com/info/tea](http://www.ukipme.com/info/tea) NOW!



# CUSTOMIZED TEST DYNOS

One specialist in motor applications is also providing the aerospace testing industry with a wide range of customized precision test systems

The nature of the aerospace industry is complex and ever-changing. Higher speed and energy capabilities are required in its testing environment, shaping the development of unique testing equipment. Drawing from more than 80 years of experience in testing, Link Engineering Company has the ability to work through these evolving and demanding customer challenges to create innovative, cost-effective, custom solutions. With a strong balance of knowledge and determination, Link continues to develop new and intricate equipment to meet the constantly elevating demands of the aerospace industry.

Most recently, Link completed two projects for a world leader in aircraft landing and braking systems. These projects included one high-speed and low-inertia aircraft shaft dyno and one low-speed and high-inertia aircraft shaft dyno. These aircraft inertia dynamometers provide the capability to analyze aircraft brake components under dynamic and semi-static conditions. The shaft-style dynamometers provide the ability to replicate a wide range of simulations as seen by the aircraft's brake system.

These aircraft dynamometers were manufactured from unique designs and formulated for customers' specific development needs. Together the dynos 'soar' at 3,000rpm on the high-speed dyno and reach an inertia of 15,000kg\*m<sup>2</sup> on the high-inertia dyno. Both operate with fully automated controls and are also equipped with a selectable fully manual control mode for impromptu development testing. These dynamometers were designed with integrated subsystems for seamless control and data acquisition, and come with a fully insulated, expansive test enclosure.

Barthelemy Chauvois, wheel and brake tests engineer and program manager for Safran MBD, the new test rig owner, says,

"The Link brake dynamometer has provided our engineering team with an advanced and reliable tool for understanding our brake system's capabilities by putting ProLink and data processing into the hands of every active development engineer. Thanks to Link technology and support, the ability to develop and validate a new design is invaluable."

Link thrives on opportunities to maximize design, manufacturing and operating efficiencies to create custom design work. These two

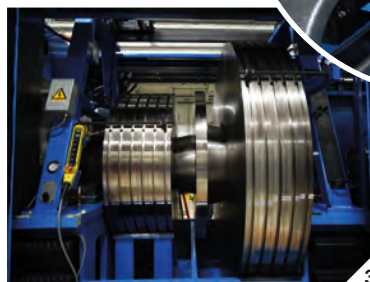
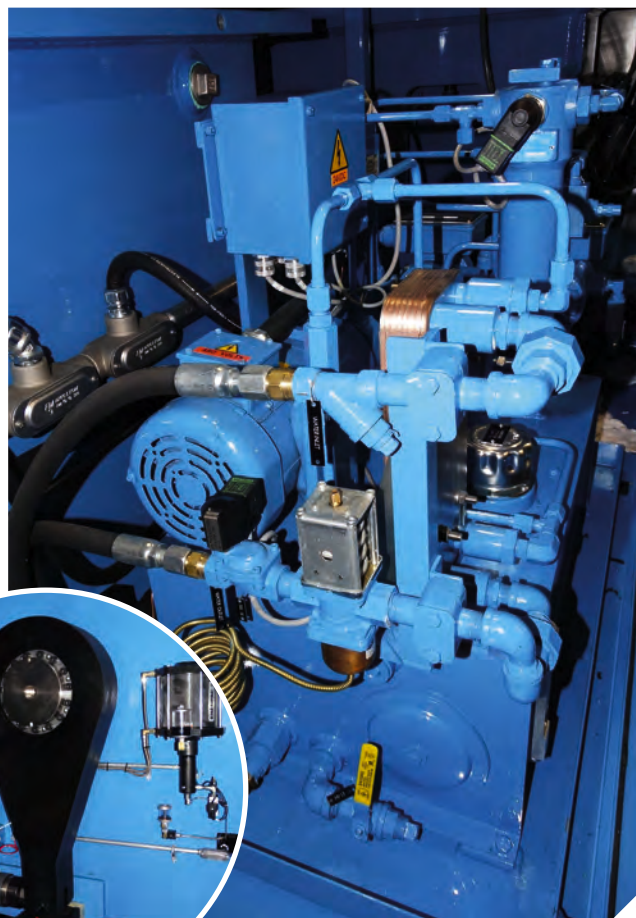

- 1 // Hydraulic power unit
- 2 // Tailstock torque arm on aircraft shaft dyno
- 3 // Inertial disks on the high-speed aircraft dyno
- 4 // Instrument box high-speed dyno

aerospace dynamometers were produced with a mechanical base inertia in conjunction with electric inertia simulation (I-SIM). Through the use of dynamically controlled motor torque (I-SIM), an infinitely adjustable level of inertia can be produced. The entire system boasts an integrated uninterruptible power system for safe operations under any condition. The dynos also include a fully automated tailstock for rejected take-off (RTO) simulation with brake retraction from within the wheel. The systems have fully automated shaft indexing, inertia disc movement, and dual torque measurement (for improved torque measurement with or without a torque tube).

The work on these two dynos demonstrates Link's ambition for creating lasting relationships and supporting every customer from the initial design phase onward through the development process and the ongoing field service support. \\

READER INQUIRY 105

FREE READER INQUIRY SERVICE

LINK ENGINEERING

To learn more about this advertiser, visit [www.ukipme.com/info/tea](http://www.ukipme.com/info/tea) NOW!

# HIGH CHANNEL-COUNT TESTING

Vibration and modal testing systems for Chinese spacecraft development demands maximum system stability and reliability

**Q**ualification and acceptance testing on large and fragile aerospace structures such as spacecraft and satellites presents a unique challenge. Such items face the most extreme operating conditions and must meet the most stringent environmental demands. Testing plays a vital role in the development of the product and it is essential that tests on spacecraft, aircraft wings, satellites and other components are conducted safely and that all available data is captured and stored securely.

The China Academy of Space Technology (CAST) is China's main spacecraft development and production facility. Its space programs include the Dong Fang Hong satellites, the Shenzhou Divine Craft space vessel and the Chang'e lunar orbiters and exploration vehicles. CAST has multiple subsidiaries. One of them, the Research Institute (Institute of Assembly and Environmental Engineering) in Beijing, conducts a wide variety of dynamic and reliability tests and environmental

simulations. The Institute, which is one of the largest spacecraft environment test centers in the world, performs simulation and acceptance tests for spacecraft and satellites on large-scale test equipment. For example, the Chang'e 2 satellite was subject to a series of closely defined and strictly controlled tests to achieve the final sign-off before its launch.

CAST selected m+p international's m+p VibControl and m+p Analyzer software for data acquisition, post-processing and modal testing, using the m+p VibRunner hardware.

The system has 456 channels of analog input and eight channels of analog output. It has two racks that accommodate 20 m+p VibRunner modules and two servers that are used for throughput recording and data sample processing.

The system is used in aerospace dynamics environmental testing, including swept sine and random vibration test, noise test, shock response spectrum analysis, impact test and modal analysis.



- 1 // m+p international's dynamic testing instrumentation
- 2 // International space station
- 3 // Parallel time history recording and random vibration testing

Large specimens such as the Chang'e 2 satellite have hundreds of critical locations where vibration data must be monitored and recorded during a test. To make sure all the data is captured, a time domain throughput facility in m+p international's system was used in both sine and random data reduction modes. This enables time data to be stored in addition to frequency data. This is crucial for critical aerospace testing, where high numbers of channels are required for post-test and possible failure analysis. The time history data is recorded in parallel with vibration control without reduction in control performance. With m+p international's wide range of input ranges and filter functionality, all the test requirements can be fulfilled.

For high-end vibration and modal testing, the stability of the system and absolute confidence in the test data are crucial. Engineers at the Institute of Assembly and Environmental Engineering are delighted with the excellent stability and reliability of m+p international's advanced test equipment. As a result, CAST now has several m+p VibControl and m+p Analyzer systems with a total of over 1,000 input channels. \\\



READER INQUIRY 106

FREE READER INQUIRY SERVICE

**M+P INTERNATIONAL**

To learn more about this advertiser, visit [www.ukipme.com/info/tea](http://www.ukipme.com/info/tea) NOW!



# WIRELESS REDUCES TESTING DELAYS

Wireless sensors using an innovative communication technology can be added to existing installed flight test instrumentation to reduce setup or modification time for testing

**D**uring a flight test campaign, it is vital that the aircraft being tested is available to fly and is kept in the air as much as possible. Any unplanned time on the ground can add significant cost and delay to the test campaign. But life is unpredictable. It sometimes happens during the course of a test campaign that new instrumentation or new measurements will be required. For example, some unexpected data might emerge during the flight test, making it critical to add additional sensors.

Addressing these unpredictable issues typically requires the aircraft under test to be grounded so that the additional sensors or data acquisition units (DAU) can be installed and the data acquisition system (DAS) rewired to support them. That makes the rapidity and accuracy with which the DAS can be rewired and new instrumentation added a major consideration.

The problem can be exacerbated when it's also necessary to drill through the aircraft's bulkhead or attach a new DAU near rotating parts. Such changes require significant effort and paperwork, all of which add time and cost. The good news is that there's a better approach for quickly modifying the existing DAS architecture that minimizes the grounding of the aircraft so that testing can resume as soon as possible.

The solution is to use wireless sensors to add the additional functionality to the DAS.

Flight test instrumentation (FTI) wiring harnesses are heavy and bulky and take much effort to install. Any late changes in sensor requirements involve removing, taking apart and re-installing the wiring harness. Because they eliminate the need for a wiring harness, wireless sensors are much easier to install and integrate into an existing DAS. Additionally, wireless sensors are ideal for hard-to-reach locations where drilling holes for wiring looms or locating a DAU in close proximity might prove difficult. Having an

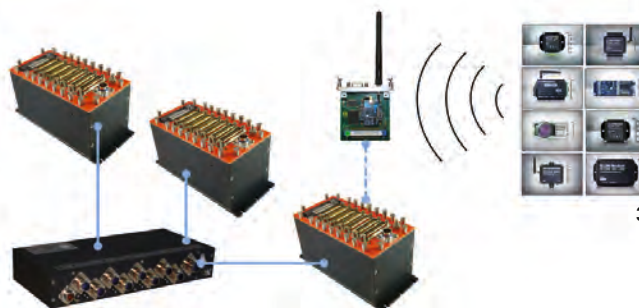

option to add wireless sensors to enhance the existing wired DAS provides the flexibility needed to meet unexpected test campaign requirements while reducing the time and complexity of expanding the test architecture.

Until now, a number of challenges have prevented wireless sensors from being widely adopted for FTI. Investigation into the use of an IEEE 802.15.4 physical layer wireless network (the basis of popular ZigBee wi-fi networks) in FTI DAS architectures has revealed a number of negative issues. Traditional wired network sensors have an exclusive link to the acquisition hardware at the data transmission level, which means that no problems with network contention can arise. In comparison, several sensors on a wireless network might contend for access to the available bandwidth. While network contention in an office environment can be effectively mitigated with a Carrier Sense Multiple Access with Collision Avoidance (CSMA/CA) protocol, it's not an attractive option for FTI. CSMA/CA introduces problems in an FTI environment, the most deleterious of which is the potential introduction of packet latency and a reduction in the transmit determinism. Another critical issue for FTI is data synchronization. Again, while IEEE 1588 Precision Time protocol is widely used to



**1 //** An Acra KAM-500 DAU with a KAM/WSI/104 wireless module

**2 //** The KAM/WSI/104 wireless sensor network interface module

**3 //** Curtiss-Wright's KAM-500 DAUs, connected with a network switch, can use wireless sensor data from a KAM/WSI/104 module to simply and speedily add new instruments needed during a flight test campaign

address this problem in wired networks, this standard does not perform well over a wireless link.

Recently, though, a solution has emerged that enables the use of wireless FTI sensors while eliminating key problems such as packet delays. This solution uses LORD MicroStrain's Lossless Extended Range Synchronized (LXRS) gateway technology. LXRS is a 2.4GHz IEEE 802.15.4-compliant communication architecture wireless protocol that combines microsecond time-synchronization with a scalable star network to provide precise, comparable measurements on a distributed wireless network. It enables user-controllable sampling rates to be automatically coordinated over thousands of wireless sensor nodes, all with 100% reliable data throughput under most operating conditions. LXRS's support for transmission range of up to 2km and lossless data throughput under most operating conditions make it an ideal alternative to ZigBee for sensor monitoring, data acquisition, performance analysis and sensing response applications.

Using LXRS makes it possible to rapidly add wireless sensors to an existing, already installed FTI DAS architecture. An example of one such implementation is the LXRS protocol for FTI applications is Curtiss-Wright's KAM/WSI/104 wireless module, which is designed to work with its KAM-500 DAU. The fully integrated solution seamlessly supports both wired and wireless test elements in a single box. Each channel on a remote LXRS node is represented as an analog channel on the KAM/WSI/104 and can present data as a single parameter, which can be placed in PCM or Ethernet frames.

Now, with the option to add wireless sensors during the course of an FTI campaign, test campaigns don't have to halt in midstream to capture critical data. Wireless lets you keep your test platform up in the air, where it belongs. \\\

READER INQUIRY 107

FREE READER INQUIRY SERVICE

CURTISS-WRIGHT

To learn more about this advertiser, visit [www.ukipme.com/info/tea](http://www.ukipme.com/info/tea) NOW!

# COMPUTED TOMOGRAPHY NDT

Inspection of additive manufactured parts has often required destruction of a part to find the imperfections. Now computed tomography offers a powerful non-destructive alternative for aerospace

**A**dditive manufacturing (AM) has gained incredible interest from all industries. From aerospace applications to simple one-off consumer home-builds, this technology has immense versatility. In AM, objects are built by adding layer upon layer of material. Some current materials include varieties of plastics, even chocolate, glass, and metals, with more advanced materials actively being developed.

With all these materials in use, many products are being created for critical applications in aerospace, medical, automotive and other industries. How does the manufacturer inspect these products to ensure the safety and longevity possible with conventional manufacturing methods?

Computed tomography (CT) is a unique and powerful tool that provides the ability to inspect the product for defects or anomalies, take internal and external measurements, and create a model or drawing from the product. A key benefit of this technology is for non-destructive inspections. CT provides a way to replace timely cross-sectioning for inspection and scrapping of the first article to examine internal features. The product can be used as intended afterward.

CT gives the ability to image a product and gather a number of 2D digital radiographs, which are typically done in 360° of rotation. These radiographs are processed through software that generates a CT volume display. The data is displayed as three-dimensional voxel (a 3D pixel) data - this image can be viewed at different angles.

Manipulation of the 3D model includes extensive visualization capabilities for the volume and 2D slices. Clipping planes in 2D allow the operator to cut through the sample in multiple directions for evaluation from almost any angle. From a clipping plane, a 2D image allows the user to enlarge an area of interest and take measurements at specific points.



1

A product made of titanium was produced using the AM process and imaged at two scan resolutions to show the ability of locating sections of interest. Even though the term scan resolution is commonly interchanged with scan voxel size, the two are not necessarily the same. Although it is possible to detect indications [anomalies] equal to the size of a single voxel, there are other variables such as contrast that can impact true scan resolution. For this article we will compare scans based on different voxel sizes.

Many questions need to be addressed prior to scanning to accomplish the required task. For example, what is the minimum voxel size necessary to provide a high probability of detection for a given indication size? It is advantageous to use a technique that generates a voxel size that provides for multiple voxels to be contained within a known indication. For example, if one is attempting to find a 45µm indication, a technique that achieves a 15µm voxel size would provide a 3 x 3 x 3 voxel cube with 27 voxels representing the indication, versus just 1 voxel. This will generate a higher probability of detection of the indication.

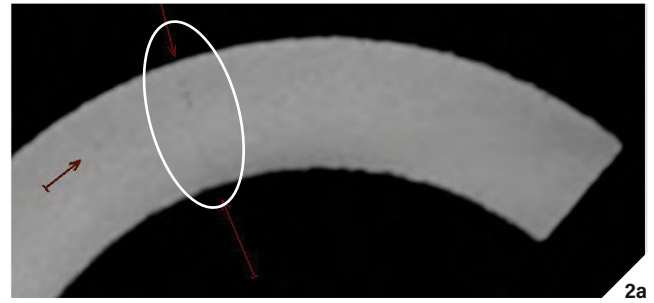

2a

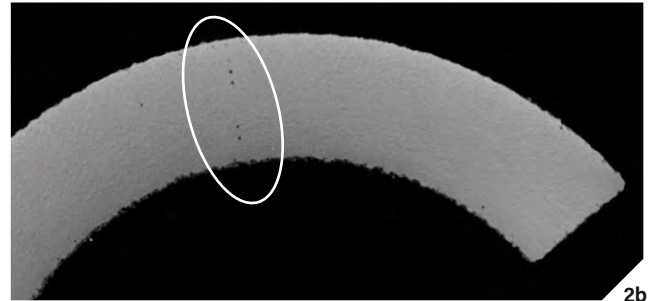

2b

**1 //** An initial scan was performed over the full part, which yielded a 45µm voxel model. Indications of voids or lower density inclusions are evident. From this, an isolated area was chosen for enhanced rescanning

**2a //** The specific area at the top of the model showed areas of interest (red arrows)

**2b //** A rescan was done using a voxel size of 15µm, which yielded a smaller region of interest and improved image detail along with a higher probability of indications being detected

**3a //** The 45µm data shows indications of lower density near the inner edge, but they appear blurry in this image

**3b //** With a 15µm increased resolution voxel data scan, the same indications are now more defined and contrast is also increased

CT also provides evaluation of the internal integrity of products and the ability to take internal and external measurements. To further enhance measurement capability, a polygonal wire mesh (Figure 3B) can be applied to the surface, defining edges and features to allow for increased measurement accuracy. The data is stored in different point cloud data formats, .PLY, .STL, etc. This is then used for measurements or comparison in CAD software programs.

One key advantage of CT for detecting defects in AM products is as a powerful NDT tool in metrology applications. \\\

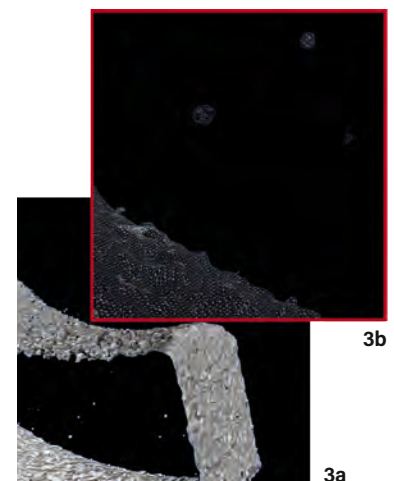

3b

3a

READER INQUIRY 108

FREE READER INQUIRY SERVICE

NORTH STAR IMAGING

To learn more about this advertiser, visit [www.ukipme.com/info/tea](http://www.ukipme.com/info/tea) NOW!



# MECHANICAL SHOCK TESTING

Aerospace vibration tests are critical and IMV has long offered a wide selection of services at worldwide locations, including its newest battery testing facility near Tokyo

Vibration testing is critical for aircraft equipment and responding to special demands such as for large specimens or using multishaker methods (multiple-input multiple-output – MIMO) is becoming important for the test industry. IMV Corporation has opened the Advanced Technology Centre for Environmental Testing in Yamanashi Prefecture, central Japan, 45 minutes by car from central Tokyo. This new test facility serves the company's international customers and provides high-level technical support for local companies. IMV's existing Tokyo test laboratory is just 15 minutes away and the combined services of both labs strengthen the capabilities offered and improves the responsiveness to customers' needs.

IMV is well known for electrodynamic vibration test systems and has a long history of providing testing and consultancy services to major automotive customers such as Toyota, Nissan and Honda. Japanese automotive manufacturers' vehicles have received high quality ratings in market studies and IMV has been a critical partner in achieving this success.

The company offers high-level technical capabilities and services, which have been developed through years of experience. In addition to aerospace and automotive, they can be found in a number of industries. Japan's first vibration and shock test laboratory was established by IMV in Kanagawa in 1998. Since then, IMV has been expanding its test laboratory business, with the establishment of advanced centers in Osaka (2005), Nagoya (2007) and Thailand (2012). This wealth of experience and technical capability is available for all IMV's international customers. Working in



1

1 // MIMO shaker system: a test for huge/ long devices under test

2 // Push-pull shock tester: an ultra-long stroke capability (600mm/p-p)

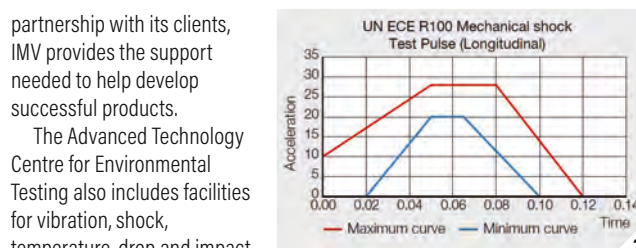

2

partnership with its clients, IMV provides the support needed to help develop successful products.

The Advanced Technology Centre for Environmental Testing also includes facilities for vibration, shock, temperature, drop and impact tests for lithium-ion batteries to the international standard UN ECE-R100. Additionally, there is a large vibration test system, which has a 2,000kg specimen capacity. The test zone offers high-level, traditional vibration/shock testing and has responded to the growing demand for mechanical and electrical testing of lithium-ion batteries.

The new IMV facility has full testing capability for mechanical shock testing and charge/discharge testing of Li-ion batteries. The center is divided into separate battery and vibration testing zones. Battery testing includes charge-discharge systems, which enable center users to perform complete battery pack evaluation with ease. Shock velocities in excess of 3.5m/s can be replicated using IMV's recently installed A-class shaker series (65kN air-cooled systems). The zone has been designed with

3 // New shock profile for Li-ion battery specified in UN regulations. Shock tester in Figure 2 can control this profile with high accuracy

safety in mind. It is equipped with a variety of fire prevention measures and explosion-proof systems including: carbon monoxide concentration meters, temperature sensors; pressure relief dampers, anti-flammable vents, twin fireproof doors with thicknesses of 150mm and 300mm, an exhaust gas treatment scrubber, and cameras with monitoring screens.

The vibration testing zone is equipped with an ultra-large vibration test system, which can be configured for long specimens and has a force rating of up to 200kN, using a push-pull method. To support the various needs of the test center users, the zone is also equipped with horizontal and vertical vibration test systems (30-65kN) combined with climatic chambers and IMV's innovative three-axis earthquake resistance test system, which reproduces real earthquake waveforms. IMV is accredited to ISO/IEC 17025 (JIS Q 17025) for management systems for quality, administration and technical operations. Certification has been awarded by an IECQ independent testing laboratory. IMV is also accredited to Information Security Policy ISO 27001. Employee training and risk management follow ISO 27001; no business-critical or sensitive information will leave the IMV test center. \

READER INQUIRY 109

FREE READER INQUIRY SERVICE

IMV CORPORATION

To learn more about this advertiser, visit [www.ukipme.com/info/tea](http://www.ukipme.com/info/tea) NOW!

## TEST RIG SPECIALIST

**C**ERTIA provides industrial customers with test and measurement solutions across a wide range of applications including test rigs, simulation and integration, training, maintenance, research and development.

CERTIA responds to customer requirements. From a simple tool up to a complex integration test rig; from a laboratory test rig to an automatic acceptance test rig on a production line; from a mechanical unit to a high dynamic controlled loop, hydraulic power pack and services with fluids from kerosene Skydrol or FHS; from an electrical cabinet to a full real-time control/command system – CERTIA will design and deliver it anywhere in France, in Europe, or worldwide.

The company has been involved in major aerospace /defense programs since 1987. CERTIA provides test benches for: hydraulic primary and secondary actuators; electrohydrostatic actuators EHA and electromechanical actuators EMA; trimmable horizontal stabilizer actuators (THSA); thrust reverse actuator systems; gearboxes; damping systems; fuel systems; and much



more. All Airbus aircraft are supplied with components or systems that are validated on CERTIA test benches.

The company's main customers include the manufacturers Airbus, Eurocopter, Nexter, Renault, PSA; the OEMs Safran Group, Zodiac, UTC/UTAS, CIRCOR; and the MROs Air France and Air Algerie. All have selected CERTIA as a supplier for their most critical test rig development projects. \\\

FREE READER INQUIRY SERVICE

**CERTIA**

To learn more about this advertiser, visit [www.ukipme.com/info/tea](http://www.ukipme.com/info/tea) NOW!

READER INQUIRY 110

## SWASHPLATE SOLUTION

**H**elicopter rotors are exposed to highly asymmetric aerodynamic conditions, because the flows resulting from the forward movement of the helicopter and the rotation of the blades overlap during forward flight. This leads to noise and vibrations with the rotor's rotational frequency and integer multiples thereof (rotor-harmonic frequencies). To minimize these effects, the DLR (German Aerospace Center) has developed a novel multiple-swashplate system (META) capable of individual blade control.

The META concept uses electrohydraulic actuators that induce high-frequency movements of multiple concentric swashplates to change the pitch angles of the blades and counteract noise and vibration. The actuators are installed below the swashplates, which are each connected to two blades of a four-blade rotor model. This design allows for transmission of arbitrary pitch control signals to the individual rotor blades without using technically more complex actuation systems in the rotating frame.

High demands were placed on the dSPACE system in terms of both accuracy and sampling rate, with only 250µs available for each control step. The multiple-swashplate system successfully completed its first wind tunnel test in September 2015. The test showed a noise reduction of up to 5dB and a vibration reduction of up to 90% in single components. \\\

## MOBILE WIRE TESTING

**N**ow it is easier than ever to take your wire harness test system into the field for maintenance of deployed systems.

At just under 15kg, DIT-MCO's Model 2635 goes where it is needed. Its small size means it will fit into tight quarters such as an aircraft flight deck or equipment bay. Operate it from AC and DC power, or choose the optional battery pack for up to two hours of continuous operation.

With up to 400 test points, the Model 2635 tests wiring and components for leakage, resistance, voltage and capacitance. The programmable instrument provides stimulus at voltages of 0.225V DC to 1,500V DC, and current up to 2A.

The 2635 can operate from any computer or can be equipped with an embedded controller and LCD touch display. The test software facilitates an intuitive HMI (human machine interface) through the touchscreen.



The 2635 test system is encased in a lightweight molded case. This rugged design is resistant to impact, moisture and corrosion. The convenient extension handle and wheels make transporting the system as simple as carrying a small suitcase.

DIT-MCO has a solution for all your wire harness testing needs. \\\

FREE READER INQUIRY SERVICE

**DIT-MCO**

To learn more about this advertiser, visit [www.ukipme.com/info/tea](http://www.ukipme.com/info/tea) NOW!

READER INQUIRY 111

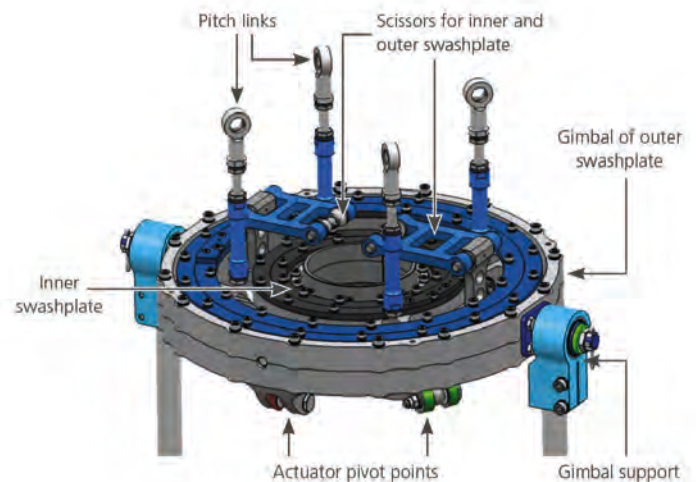

Source: © DLR

FREE READER INQUIRY SERVICE

**DSPACE**

To learn more about this advertiser, visit [www.ukipme.com/info/tea](http://www.ukipme.com/info/tea) NOW!

READER INQUIRY 112



# TESTING CAN SYSTEMS

Aircraft manufacturers, suppliers and airlines are increasingly relying on controller area network (CAN) systems in future aircraft programs. To meet the stringent requirements for robustness, reliability and long service life, there is an increasing demand for efficient measurement and test methods on the CAN physical and logical layer.

To detect potential communication errors before they occur, synchronous analysis of both layers is required. Measurements without any reference to the logical CAN events are difficult to configure, interpret and evaluate. For this reason, Vector has added powerful oscilloscope functions to its CANoe and CANalyzer test and analysis tools for CAN.

The 'Scope' option uses a common time base for oscilloscope data and CAN event data, which allows a completely synchronized display of the recorded CAN frames and the corresponding CANbus signal. CANoe/CANalyzer Scope is based on USB

oscilloscope hardware and supports four- and two-channel solutions with bandwidths of 200MHz and 60MHz; the sampling rate is up to 50 mega samples/second in each case.

The Vector solution described speeds up primary troubleshooting, and allows an evaluation of the signal quality and robustness. Extensive triggering and programming options, combined with high-performance test automation, support developers during troubleshooting and optimization of their CAN networks. \\\



FREE READER INQUIRY SERVICE

VECTOR

To learn more about this advertiser, visit [www.ukipme.com/info/tea](http://www.ukipme.com/info/tea) NOW!

READER INQUIRY 113

# VIBRATION FAULT DETECTION

Aircraft components demand flawless functionality and durability. For components encountering harsh vibration environments, early fault detection is absolutely vital. Designers and analysis engineers can quickly and easily check for design issues using nCode VibeSys, a comprehensive tool for detecting early symptoms of noise and vibration problems in

rotating machinery (for example engines) and identifying their root causes.

nCode VibeSys contains a set of pre-defined processes for performing various types of analysis on rotating machinery. Results can be reviewed in a number of ways, including waterfall displays and Campbell plots. VibeSys also contains order-tracking and filtering capabilities, enabling engineers to easily identify dominant orders and pinpoint the roots of high vibration levels.

Additionally, nCode VibeSys enables a component's vibration environment to be characterized in terms of a fatigue damage spectrum (FDS) and a shock response



## Aerospace TESTING INTERNATIONAL.COM

- > All the latest news <
- > Exclusive features <
- > Industry interviews <
- > Expert opinion <
- > Video gallery <
- > Recruitment section <
- > Digital edition and magazine archive <







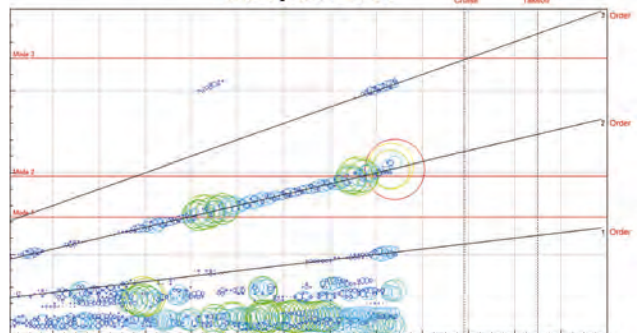

[www.aerospacetestinginternational.com](http://www.aerospacetestinginternational.com)

Campbell Plot



spectrum (SRS) using the accelerated testing module. Based on this information, VibeSys can then generate an accelerated vibration test spec with the same amount of damage and the same failure mechanism that can be run in the lab - but in a much shorter period of time. \\\

FREE READER INQUIRY SERVICE

HBM PRENSCIA

To learn more about this advertiser, visit [www.ukipme.com/info/tea](http://www.ukipme.com/info/tea) NOW!

READER INQUIRY 114

## ZERO-GRAVITY TESTING

The NASA Glenn Research Center Zero Gravity Facility conducts zero- or low-gravity experiments to support the development of space technologies and basic research. This NASA asset is the largest low-gravity test facility in the world, providing a high-quality low-gravity environment for five seconds of test time.

Jacobs is currently working with NASA to significantly improve the test-time capability, increase daily testing throughput, and provide a partial-gravity simulation capability by designing a unique linear motor drive and guide rail system.

The linear motor system will be used to launch the test vehicle and payload and to control the accelerations to simulate low- and partial-gravity environments. The improved facility is expected to provide nearly 10 seconds of zero- or partial-gravity testing



time, while using the existing concrete shaft drop tower infrastructure. \\\

FREE READER INQUIRY SERVICE

JACOBS

To learn more about this advertiser, visit [www.ukipme.com/info/tea](http://www.ukipme.com/info/tea) NOW!

READER INQUIRY 115

## SECURE DATA-LOADING

Software data-loading is becoming a more and more important issue to the aerospace industry. Data has grown in complexity and new security requirements have to be met.

Some time ago, TechSAT decided to take a long-term view – it was reasoned that supplying a common reference data-loading solution for use by all program participants, from the beginning of development to certification, and later made available for maintenance use at the launch of the aircraft in revenue service, would make an improvement in program cost, schedule and reliability.

This concept meant that maintenance users (flightline, hangar, and repair shop) would be supplied with the same data-loading tools based on the same reference tools used during key development phases. The result for all data-loading users is the supply of common data-loading tools.

TechSAT now provides a variety of data-loader systems that are Airbus approved and recommended by Boeing. The security requirements that have been recently introduced by Airbus are being fulfilled by the patented GARDT technology. This, combined with TechSAT's software part management system, supports fast and secure data-loading and eases the financial burden of airlines that operate older or current-generation aircraft. \\\

## UHT ENGINE SENSORS

PCB's Ultra High Temperature (UHT-12) sensors are made from a crystal technology that is designed for high temperature operation beyond 1,200°F (650°C) for gas turbines. Accelerometers and pressure sensors designed with UHT-12 crystals make measurements with better accuracy and lower noise during large temperature variations.

These new sensors solve gas turbine manufacturers' common problem with sensors that use ceramic and tourmaline crystals, pyroelectric noise, by eliminating the sharp spikes in the output data after experiencing large temperature changes. UHT-12 crystals have greater insulation resistance compared with ceramic and tourmaline, and this helps reduce system noise, resulting in better signal quality.

Sensitivity stability across a wide temperature range is important, and UHT-12 technology does not respond dramatically to temperature variations. ICP Series 339 accelerometers have thermal coefficients less than 0.01%/°F (0.02%/°C), maintaining flat response through the frequency range independent of temperature. Ceramic sensors



are an order of magnitude worse in their response levels.

Series 176 UHT-12 pressure sensors allow combustion instability measurements on gas turbines, for continuous diagnostics monitoring for emissions control. The higher temperature capability of UHT-12 allows for higher frequency measurements and increased thermal range since the sensor can be closer to the combustion gases. \\\

FREE READER INQUIRY SERVICE

PCB

To learn more about this advertiser, visit [www.ukipme.com/info/tea](http://www.ukipme.com/info/tea) NOW!

READER INQUIRY 116



FREE READER INQUIRY SERVICE

TECHSAT

To learn more about this advertiser, visit [www.ukipme.com/info/tea](http://www.ukipme.com/info/tea) NOW!

READER INQUIRY 117



# ETHERCAT FOR MEASURING AND TESTING

Collaboration is a big topic in 2016. Many organizations are looking for a better way to work together. Finding vendors that are committed to fully supporting open standards and protocols can be difficult. Gantner Instruments is now introducing the Q.series, an intelligent data measurement solution designed for reliable system interoperability. Typical use cases are validation and certification of aircraft components and systems, end-of-line testing, and structural health monitoring.

The Q.series measurement system is fully compliant with the EtherCAT standard and interoperable with all EtherCAT systems. The system supports two EtherCAT topologies – single I/O modules as standalone EtherCAT slaves or a cluster of I/O modules that act as a single EtherCAT slave. In this case, a secondary controller manages the single I/O modules and reports back to the EtherCAT master. This solution is ideal for high-channel count, high-resolution measurement requirements.

Recently companies including Airbus, Safran and Liebherr-Aerospace have chosen the Q.series measurement system for its high performance and flexibility. Data accuracy and precision are guaranteed due to channel-to-channel galvanic isolation, minimal drift and precise nanosecond time synchronization between all inputs and outputs. The distributed setup enables simplified installation and less wiring effort. \ \



FREE READER INQUIRY SERVICE

**GANTNER**

To learn more about this advertiser, visit [www.ukipme.com/info/tea](http://www.ukipme.com/info/tea) NOW!

READER INQUIRY 118

**FREE SERVICE!**

**LEARN MORE ABOUT OUR ADVERTISERS NOW!**



Visit [www.ukipme.com/info/tea](http://www.ukipme.com/info/tea) to request exclusive and rapid information about the latest technologies and services featured in this issue

## Index to advertisers

Aerospace Testing International Online Reader Inquiry Service .....	88	ETS Solutions .....	66	Purdue University .....	61
Curtiss-Wright .....	52	FGB: Fertigungsgerätebau Adolf Steinbach GmbH & Co KG .....	69	RUAG Schweiz AG .....	32
Adetel Group .....	54	Gantner Instruments .....	13	Siemens .....	Outside Back Cover
AIM GmbH (c/o AIM UK) .....	76	ReliaSoft .....	66	Space Tech Expo 2016 .....	86, 87
Brüel & Kjær Sound & Vibration Measurement A/S ...	Inside Front Cover	IMV Corporation .....	21	Dongling Technologies .....	57
BUSTEC .....	50	Jacobs Technology Inc .....	72	TEAC Europe GmbH .....	54
CERTIA .....	32	Data Physics Corporation .....	26	TechSAT GmbH .....	40
Cetest .....	65	Link Engineering Company .....	34	TecScan Systems Inc .....	76
DAUtec GmbH .....	Inside Back Cover	M+P International Mess-und Rechnertechnik .....	29	Teletronics Technology Corporation (TTC) .....	34
DIT-MCO International .....	69	Meteorological Technology World Expo 2016 .....	85	Test Fuchs GmbH .....	74
dSpace GmbH .....	3	MTS Systems Corporation .....	37	Unholtz-Dickie Corp .....	79
Electric & Hybrid Aerospace Technology Symposium 2016 .....	42, 45, 46	Müller-BBM VibroAkustik Systeme GmbH .....	8	Vector Informatik GmbH .....	10
Elsys AG .....	52	North Star Imaging .....	18	Weiss Technik .....	72
En Urga Inc .....	92	PCB A&D .....	74	www.aerospacetestinginternational.com .....	101

# Doc's miracle return to flight

The B-29 was the largest, heaviest bomber built for the USA in World War II. One example, Doc, was found in the desert, restored and is about to undergo testing before returning to flight after 60 years

That the B-29 Superfortress bomber 'Doc' survived at all is close to a miracle. The aircraft is one of 1,644 built in Wichita, Kansas, toward the end of World War II. In 1951 Doc was assigned to radar calibration duty with other B-29s – the squadron was known as Snow White and the Seven Dwarfs. By 1955 it was towing targets and a year later the entire squadron became bombing targets at the China Lake target range, California.

In 1987 Doc was found sitting in the Mojave Desert by Tony Mazzolini, a B-29 crewman in the 1950s and a former Continental Airlines flight engineer, but it was more than a decade before he could take possession. In April 1998 Tony and his volunteers towed Doc out of its resting place in the desert, disassembled it, and in May 2000 returned the aircraft to Wichita in sections on flatbed trailers. "By bringing Doc to Wichita, the project was able to tap into a willing, talented volunteer base with the expertise to actually complete Doc's restoration. It would not have happened without them," says Tom Bertels, board member of Doc's Friends, a non-profit group managing the restoration.

The FAA recently granted Doc an airworthiness certificate, which allows it to proceed toward the next goal – its first flight since 1956. "Ground testing so far has included balancing the 17ft diameter propellers, which was no small feat," says Bertels. More recently a low-speed taxi test has been conducted.

Last year, Doc's Friends set a target of US\$137,500 for a 30-day Kickstarter campaign to fund flight testing. When it closed, contributions from 1,007

donors totaled US\$159,151. Much more has since been raised, ensuring funding for flight testing.

The FAA has reviewed and approved Doc's flight test plan, which includes all the requirements to receive final approval for day-to-day operations, but the next steps need a runway. Doc's Friends has asked the US Department of Defense for permission to use the runway of the adjacent McConnell Air Force Base because the Wichita restoration center is not a joint-use airport (for civilian/defense). Once permission is granted, higher speed taxiing and braking tests can be conducted. "The good thing about McConnell is the length of runway," says Bertels. "Initially we can accelerate to take-off speed, pull the power back and coast to taxi speed without applying brakes. Once the crew like what they see, they can add brakes to the equation.

"As we build up to first flight, we will continue taxi testing, conduct on-runway high-speed taxi tests, and ultimately take to the sky once we are satisfied with Doc's flight-readiness. The bulk of the flight testing will occur away from McConnell within a radius specified by the FAA."

The ultimate goal is to fly Doc to various airshows and events to display the aircraft as a flying museum, but until it has been fully tested, no visiting commitments are being made. "Letting people get up close to Doc is key to our mission," concludes Bertels. "We're eager to share this wonderful aircraft with the world. Doc hasn't flown since 1956 and we think it's time to remedy that." ❧



Photos: Doc's Friends

Read more on Doc's restoration:

[HTTP://WWW.B-29DOC.COM/](http://www.b-29doc.com/)





**QUALIFY BEFORE FLIGHT**

## Destination Quality

Being qualified by DAUtec's EN 9100 certified engineering organisation, your products will be ready for takeoff.

- Aerospace Test & Qualification Services
- Environmental and EMC Testing Laboratory
- Technical Documentation
- Flight Accident Investigation



© 2016 Siemens PLM Software. All rights reserved. Siemens, the Siemens logo, and LMS are trademarks of Siemens AG. LMS Test.Lab is a trademark of Siemens PLM Software. All other trademarks are the property of their respective owners.

**SIEMENS**

# LMS testing solutions for aviation engineering.

First flight ready? You bet.

The days when noise and vibration tests were only about certification are long gone. Today, testing teams must harvest and feedback traceable and action-ready test data from all kinds of in-flight and lab-based campaigns. Their job is to perfectly perform complex tests under extreme deadlines, strict budgets and, most of the time, in tricky environments. Luckily, there are highly productive, application-specific LMS™ testing tools ready to jump right in.

Impressive speed and accuracy aside, LMS testing solutions for noise and vibration engineering from Siemens PLM Software provide real insight, transforming straightforward test data into solid engineering conclusions from design verification to final certification and troubleshooting. So whether your next project is a ground vibration, flutter, shimmy or complete acoustic testing campaign, the right scalable and efficient LMS testing solution is more than ready for you.

For more information, please visit [siemens.com/plm/lms](http://siemens.com/plm/lms)

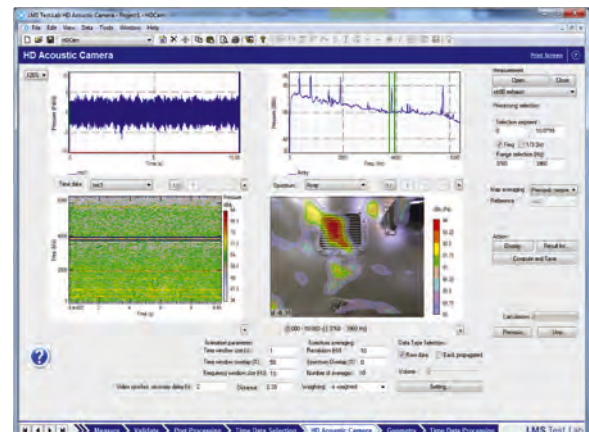

Pinpoint sound sources in seconds by combining the LMS Test.Lab™ High Definition Acoustic Camera, the LMS Circular Irregular Array with 45 microphones, and a compact 48-channel LMS SCADAS™ Recorder.

**Realize innovation.**